

1

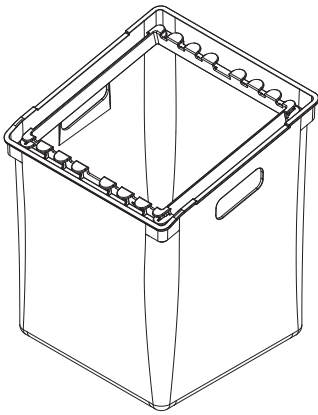

Art.-Nr. 200.1004.xx

Halter für Kehrichtsack



Montageanleitung
Assembly instruction
Instruction de montage

Halter zu S+R Eimer für abweichende Kehrichtsackgrößen
Holder system to S+R bins, which enables different sizes of bin bags to be used
Système de fixation pour poubelles S+R qui permet d'utiliser différentes tailles de sacs

6295 Mosen
Switzerland
T +41 41 919 94 00
www.peka-system.ch

2

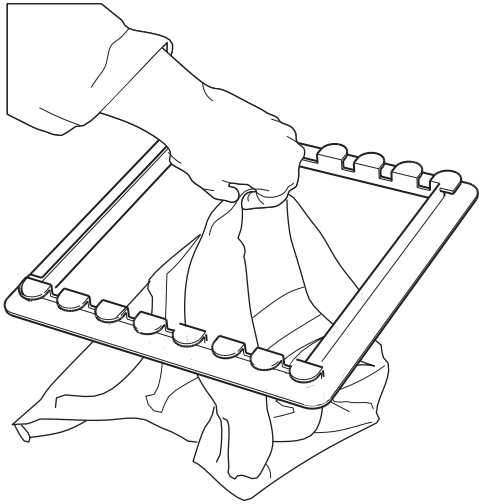

3

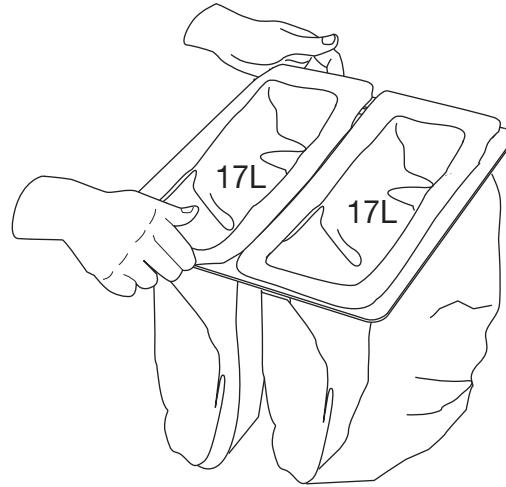

4

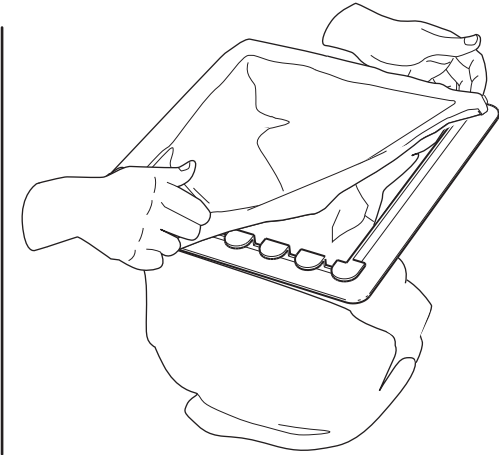

5

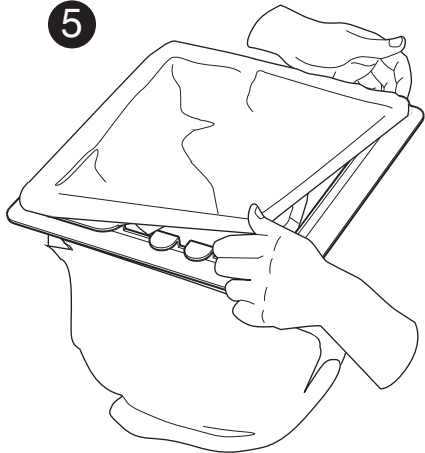

6

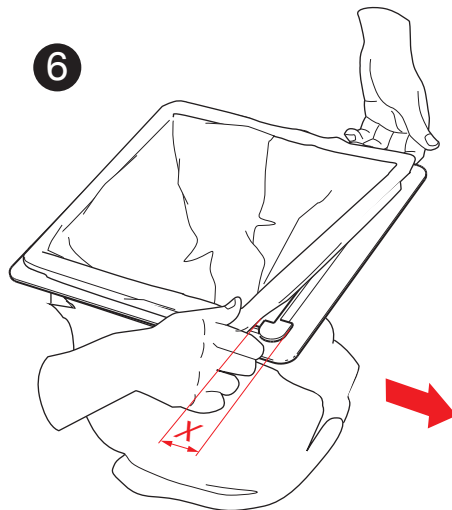

7

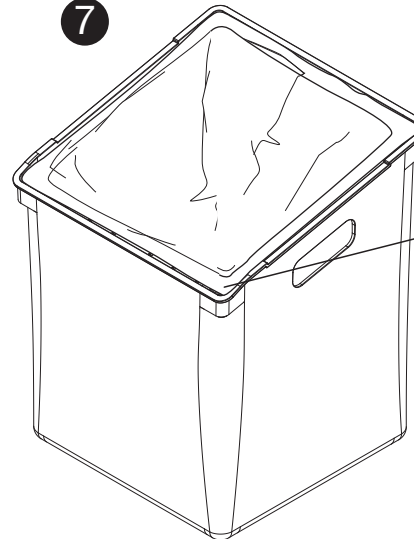

8

