

Hiddenbed ™

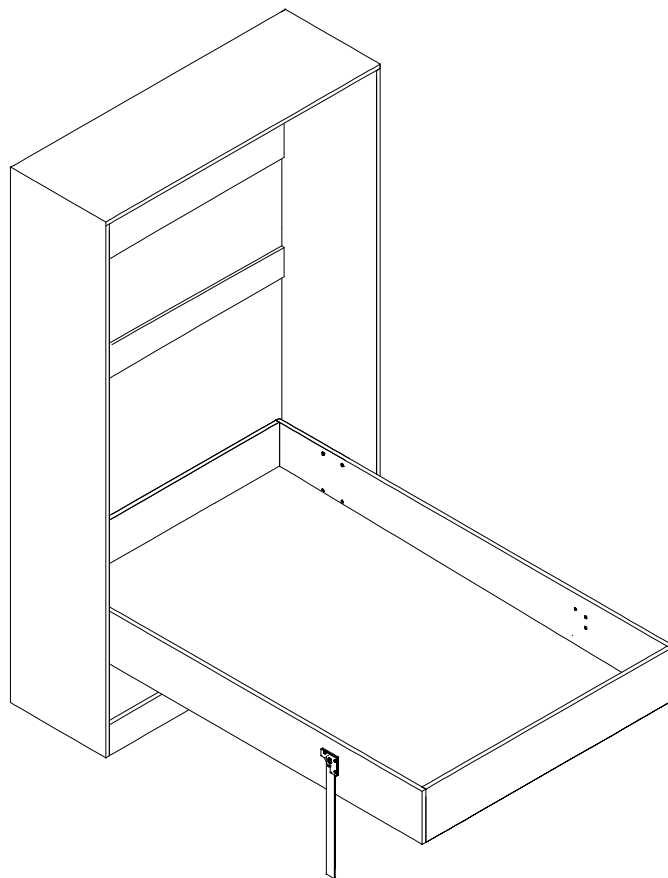
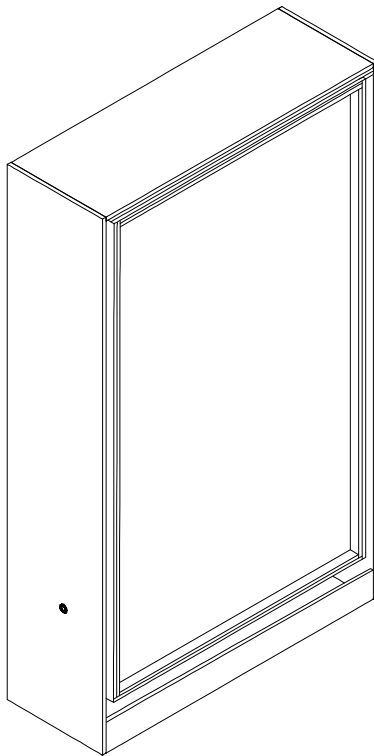

MODELO ATTRACTIVE
2000 x 1000

PRODUCTION DRAWINGS - MODEL ATTRACTIVE

TD 83 AT 1000 x 2000 CPU

All rights reserved.

Important Measurements (unit: milimeters)	Longitudinal Parts Lenght Largo Partes Longitudinales	
	Mattress lodge Alojamiento colchón 2000 x 1000	Mattress Support Soporte Colchón
Bedrail Thickness 2 x 18 Espesor Largueros		36
Mechanism Clearance Luz para Mecanismo 36 x 2		72
Shelves Estantes		1108
Low Stretcher Separador Inferior		1108

Drawings Index Indice de Planos

A - Parts List: Body and Bed	/	Lista de Partes: Body and Bed
B - Close Position	/	Posición Cerrado
C - Bed Position	/	Posición Cama
S - Furniture Screws	/	Tornillos para el Mueble
M - Mechanism	/	Mecanismo



Technical drawing suggested.
They may change according to national safety regulations.
Manufacturer must assure the correct assembly of all parts.
Remember! reference for drilling are centers.

Planos sugeridos.
Pueden cambiar según las normas nacionales de seguridad.
El fabricante debe asegurar el correcto ensamblaje de las partes.
Nota! la referencia de las perforaciones es a los centros.

BODY PARTS

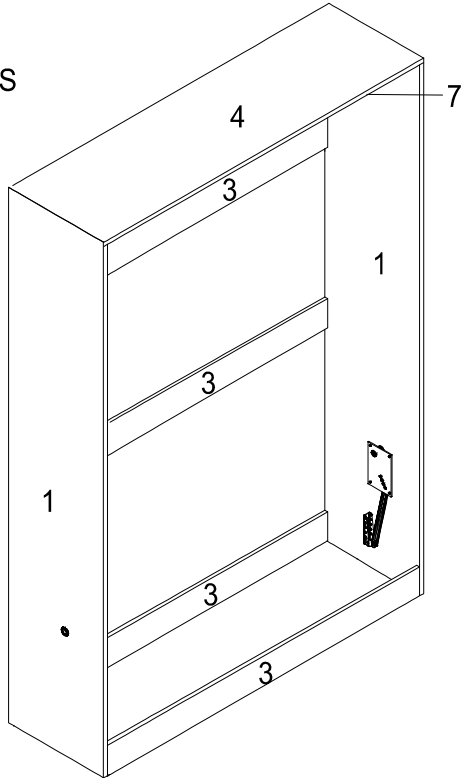

Body Parts List/ Lista de partes

Part N° N° de Pieza	Name Nombre	Qty. Cant.	Pg.
1	Body Side L/R	2	1
2	Concealer	---	---
3	Bottom Stretcher	4	3
4	Body Top	1	4
5	Shelf	---	---
6	Shelf Stretcher	---	---
7	Bed Stop	2	7

BED PARTS

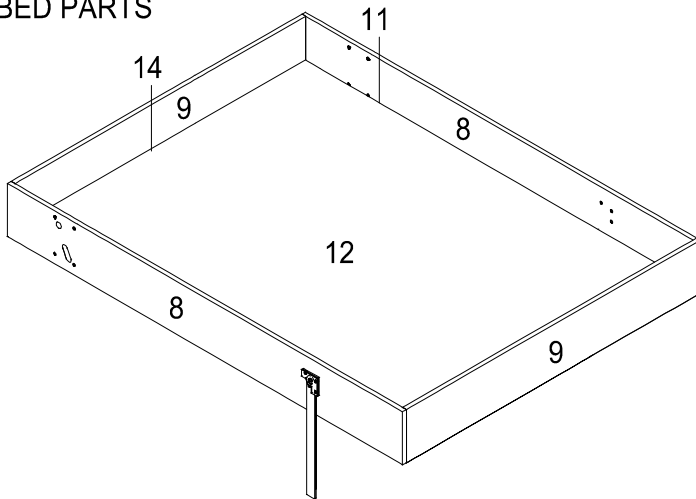

Bed Parts List/ Lista de partes

8	Bed Side	2	8
9	Bed Head	2	9
10	Bed Feet	---	---
11	Sides Cleats	2	11
12	Cover Support	1	12
13	Cover	---	---
14	Side Cleat B	2	14

CLOSE POSITION

TD 83 AT 1000 x 2000 CPU

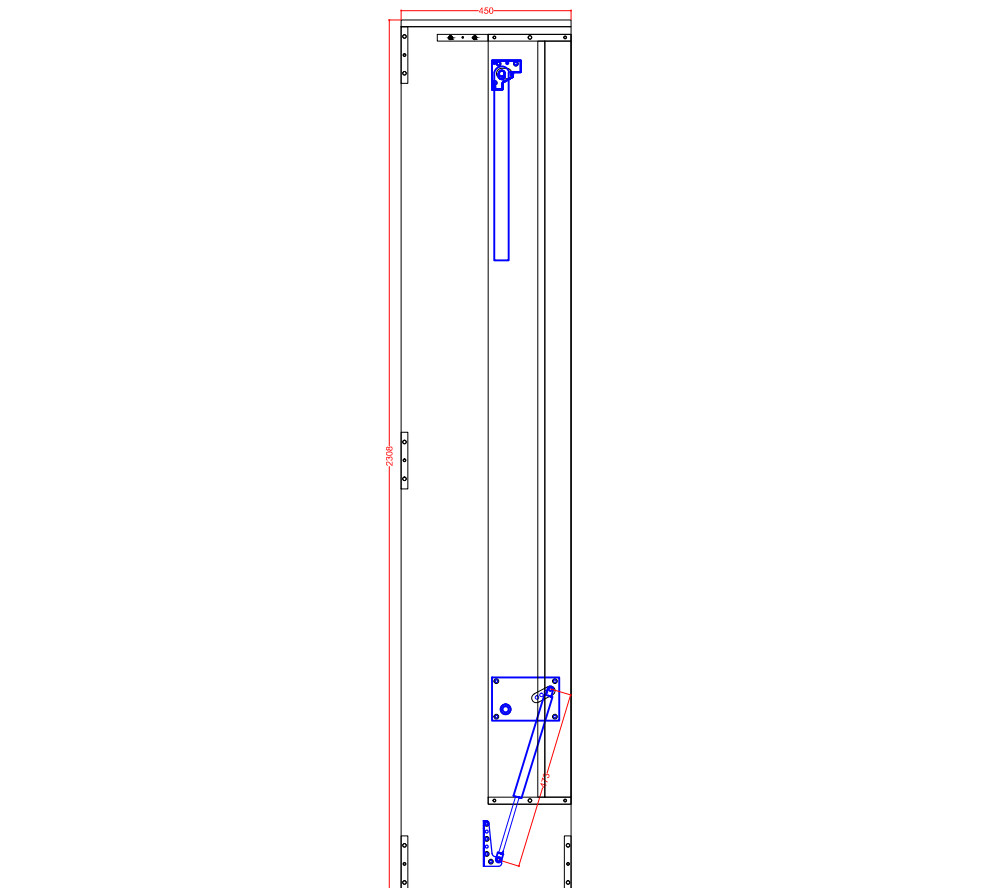
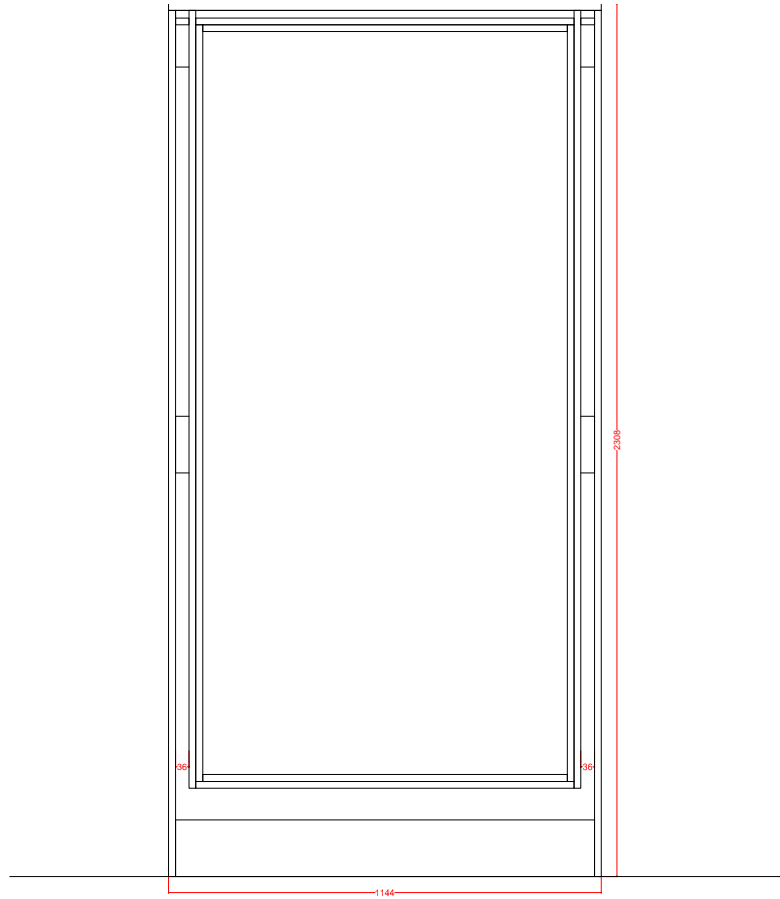

BED POSITION

TD 83 AT 1000 x 2000 CPU

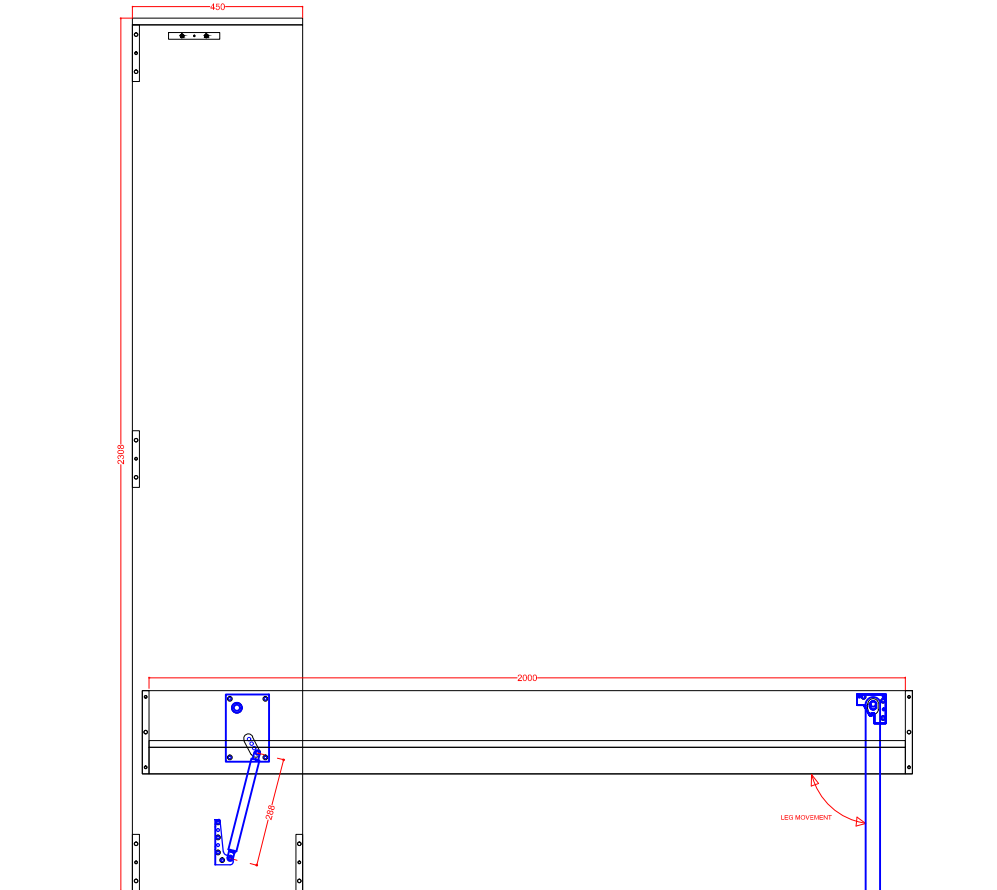
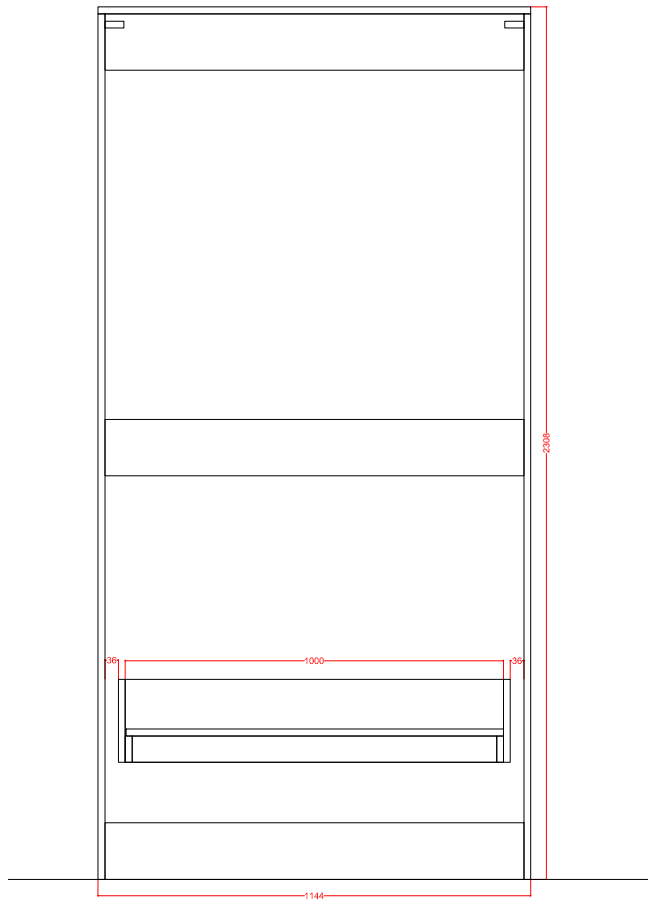







Manufacturer to verify adequate drilling diameter and depth for screw or dowel length in every place.
El fabricante deberá verificar el adecuado diámetro y profundidad de las perforaciones para cada tornillo o tarugo.

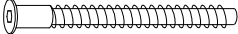
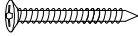

+

Drill to drive a screw position

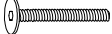
○

Drill for screw through position.

Name	Code	Dimension	Quantity	Sketch
Confirmat	H2	7x70	16	
Screw, Ph head	H14	4,5x35	30	
Dowel		10x30	24	
Flat Head Allen & T nut	H11	6x15	16	 
Round Head Allen & T nut	H12	6x30	6	 

Drawing	Screw	Quantity
1	H2	8
	H11	8
	H14	2
2		
3		16
4	H14	6
5		
6		
7		4
8	H2	8
	H12	6
	H11	8
9		4
10		
11	---	---
12	H14	22
13		
14	---	---
TOTAL		92

Bed Position

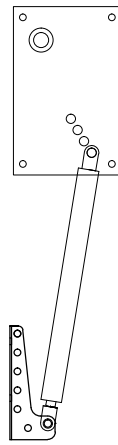

Close Position

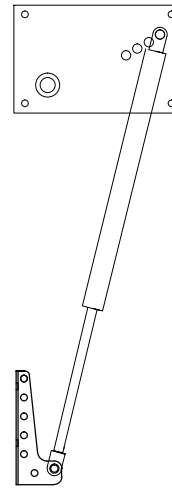

MECHANISM FIXING

S2 SCREWS RESUME:
(INCLUDED IN S1)

Carapaces

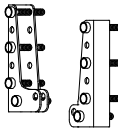

Name	Code	Dimension	Quantity	Sketch
Flat Head Allen & T nut	H11	6 x 15	8	

Mech Plate

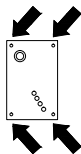

Name	Code	Dimension	Quantity	Sketch
Flat Head Allen & T nut	H11	6 x 15	8	

Leg



Name	Code	Dimension	Quantity	Sketch
Round Head Allen & T nut	H12	6 x 30	6	

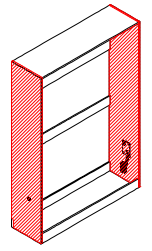

Part: Body Side

Material: MDF

Thick: 18mm

Quantity: 2

SCREW HEADS

H2 4 x 2

H11 4 x 2

H14 1 x 2

PERFORATION

A	7	PASS
B	10	10
C	3	2
D	28	PASS
E	5	PASS
F	8	13
Milling	12	2

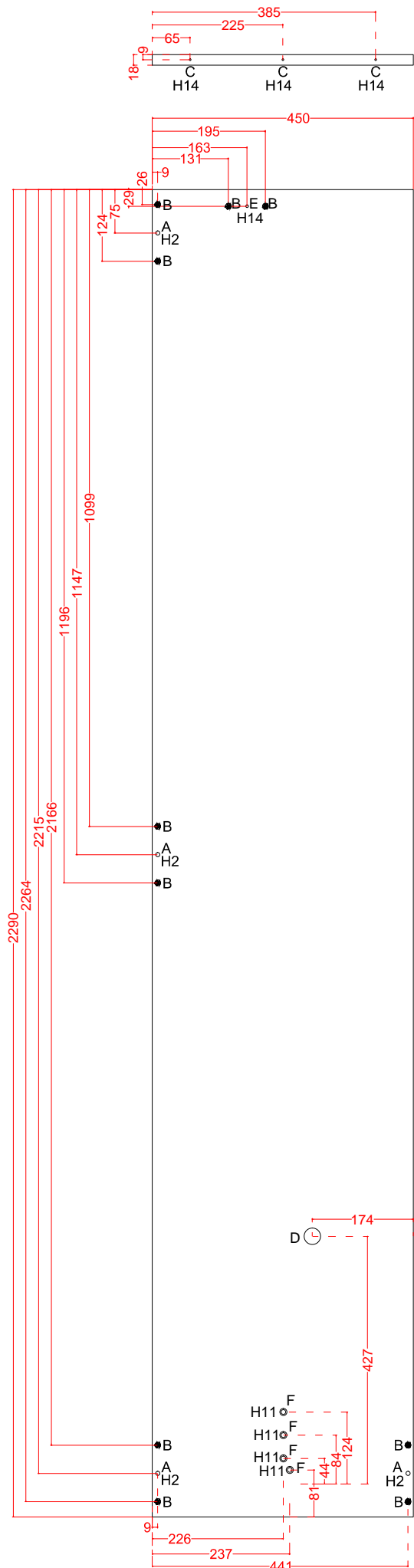

Hiddenbed™
 PATENTED SYSTEM
 © HIDDENBED 2003

CONFIDENTIAL DRAWINGS
 ALL REPRODUCTION PROHIBITED

Date: 12/11/2020

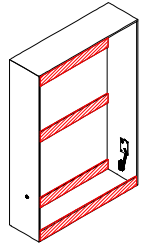

Part: Bottom Stretcher

Material: MDF

Thick: 18mm

Quantity: 4

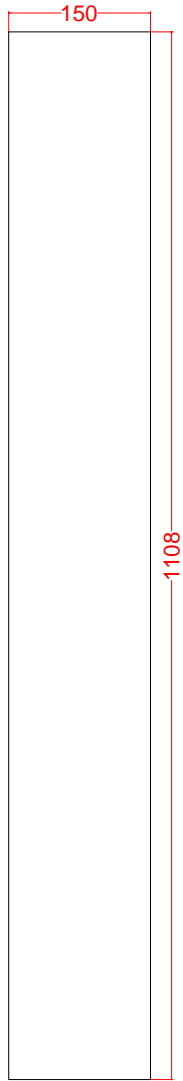

SCREW HEADS



4 x 4

PERFORATION

A	5.5	70
B	10	22

BOTH ENDS
AMBOS EXTREMOS

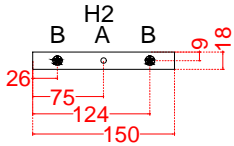

Hiddenbed™
PATENTED SYSTEM
© HIDDENBED 2003

CONFIDENTIAL DRAWINGS
ALL REPRODUCTION PROHIBITED

Date: 12/11/2020

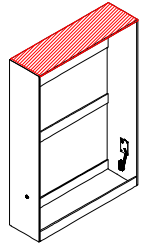

Part: Body Top

Material: MDF

Thick: 18mm

Quantity: 1

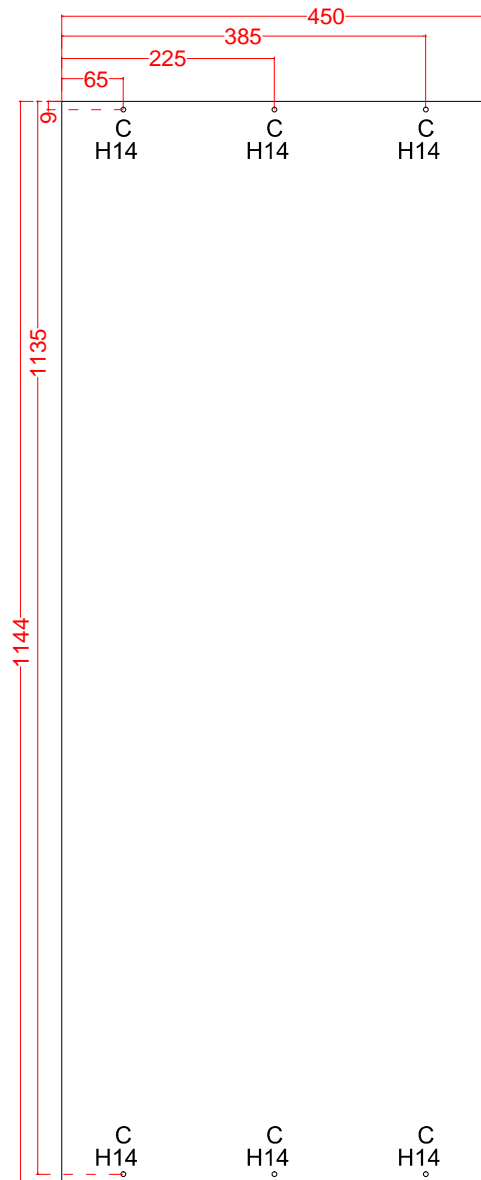

SCREW HEADS

H14	6
-----	---

PERFORATION

C	5	PASS

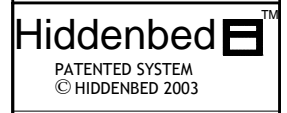

CONFIDENTIAL DRAWINGS
ALL REPRODUCTION PROHIBITED

Date: 12/11/2020

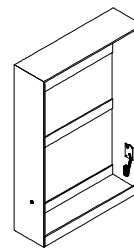

Part: Bed Stop

Material: MDF

Thick: 18mm

Quantity: 2

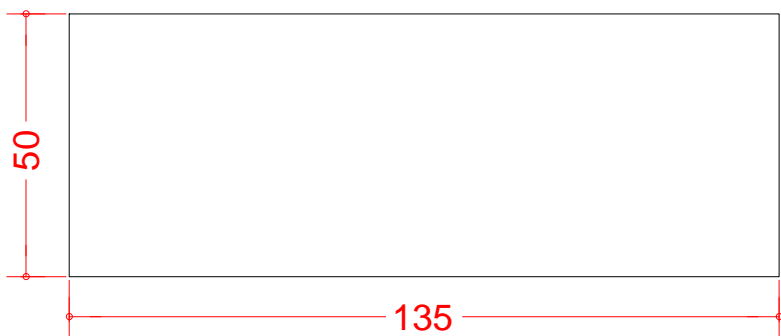
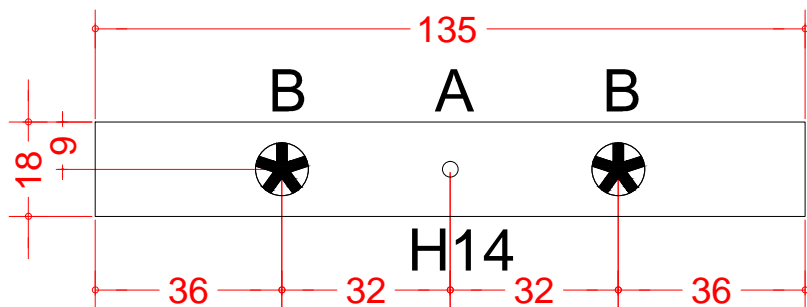

SCREW HEADS

 2 X 2

PERFORATION

A	3	2
B	10	22

Hiddenbed  TM
 PATENTED SYSTEM
 © HIDDENBED 2003

CONFIDENTIAL DRAWINGS
 ALL REPRODUCTION PROHIBITED

Date: 12/11/2020

FRONT

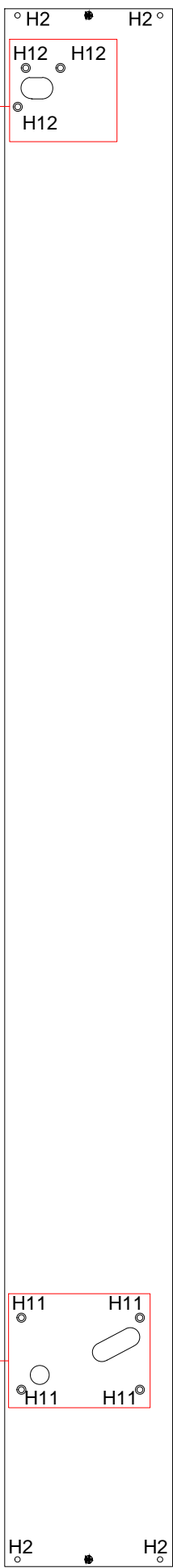

FOR LEG
on the outside

TOP

FOR PLATE
on the outside

TD 83 AT 1000 x 2000 CPU

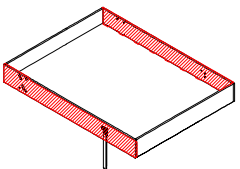

Part: Bed Side
Material: MDF
Thick: 18mm
Quantity: 2

SCREW HEADS

H2	4 X 2
H12	3 X 2
H11	4 X 2

PERFORATION

Hiddenbed™
PATENTED SYSTEM
© HIDDENBED 2003

CONFIDENTIAL DRAWINGS
ALL REPRODUCTION PROHIBITED

Date: 12/11/2020

TD 83 AT 1000 x 2000 CPU

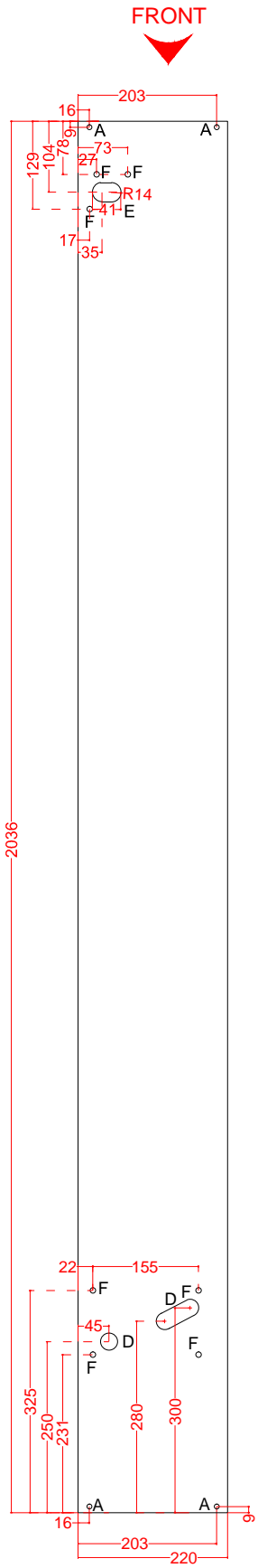
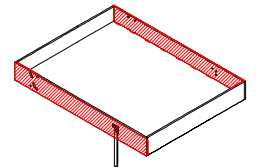

**OUTSIDE VIEW
VISTA ESTERIOR**

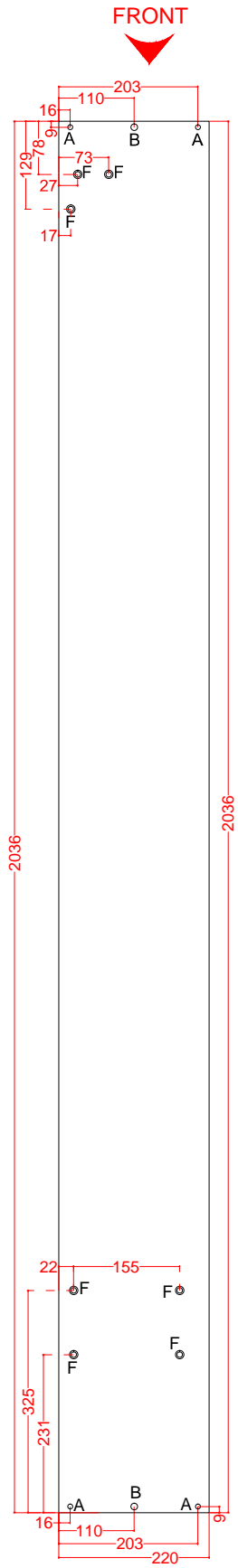

**INSIDE VIEW
VISTA INTERIOR**

Part: Bed Side

Material: MDF

Thick: 18mm

Quantity: 2

SCREW HEADS

PERFORATION

A	7	PASS
B	10	10
D	25	12
E	28	5
F	8	PASS
	12	2

Hiddenbed

PATENTED SYSTEM
© HIDDENBED 2003

CONFIDENTIAL DRAWINGS
ALL REPRODUCTION PROHIBITED

Date: 12/11/2020

TD 83 AT 1000 x 2000 CPU

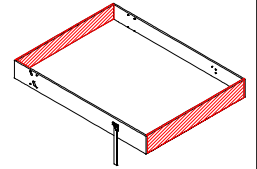

Part: Bed Head

Material: MDF

Thick: 18mm

Quantity: 2

SCREW HEADS

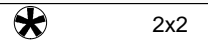

PERFORATION

	A	5.5	70
	B	10	22

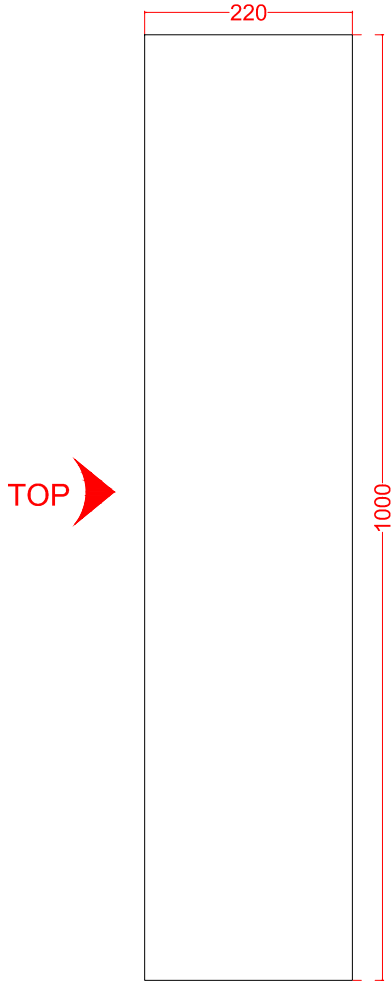

BOTH ENDS
AMBOS EXTREMOS

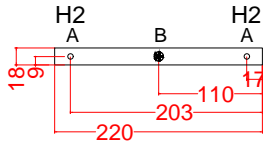

PATENTED SYSTEM
© HIDDENBED 2003

CONFIDENTIAL DRAWINGS
ALL REPRODUCTION PROHIBITED

Date: 12/11/2020

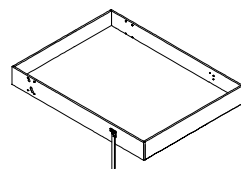

Part: Slats Cleats

Material: MDF

Thick: 70 mm

Quantity: 2

SCREW HEADS

PERFORATION

A	3	2

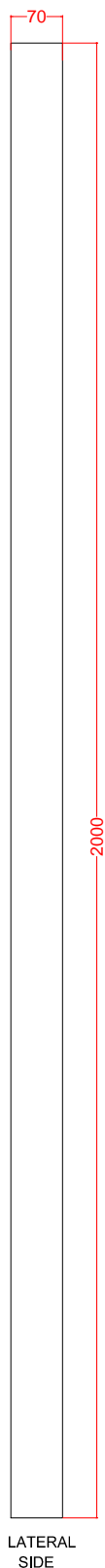
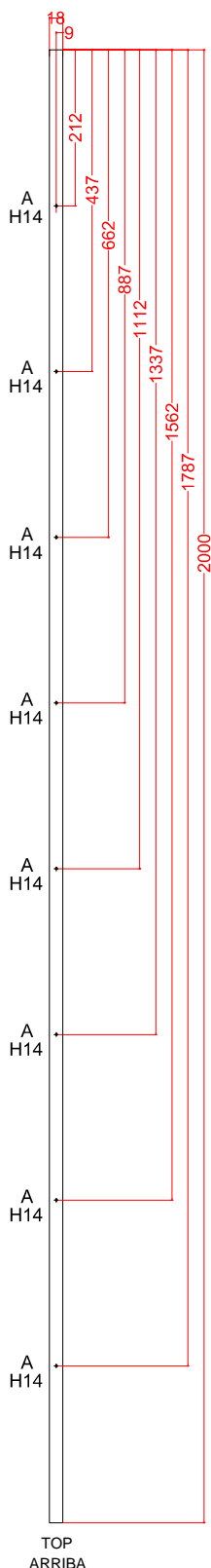

Hiddenbed
 PATENTED SYSTEM
 © HIDDENBED 2003

CONFIDENTIAL DRAWINGS
 ALL REPRODUCTION PROHIBITED

Date: 12/11/2020

TD 83 AT 1000 x 2000 CPU

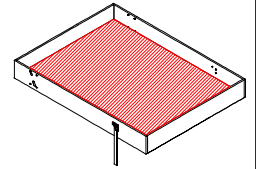

Part: Cover Support

Material: MDF

Thick: 18mm

Quantity: 1

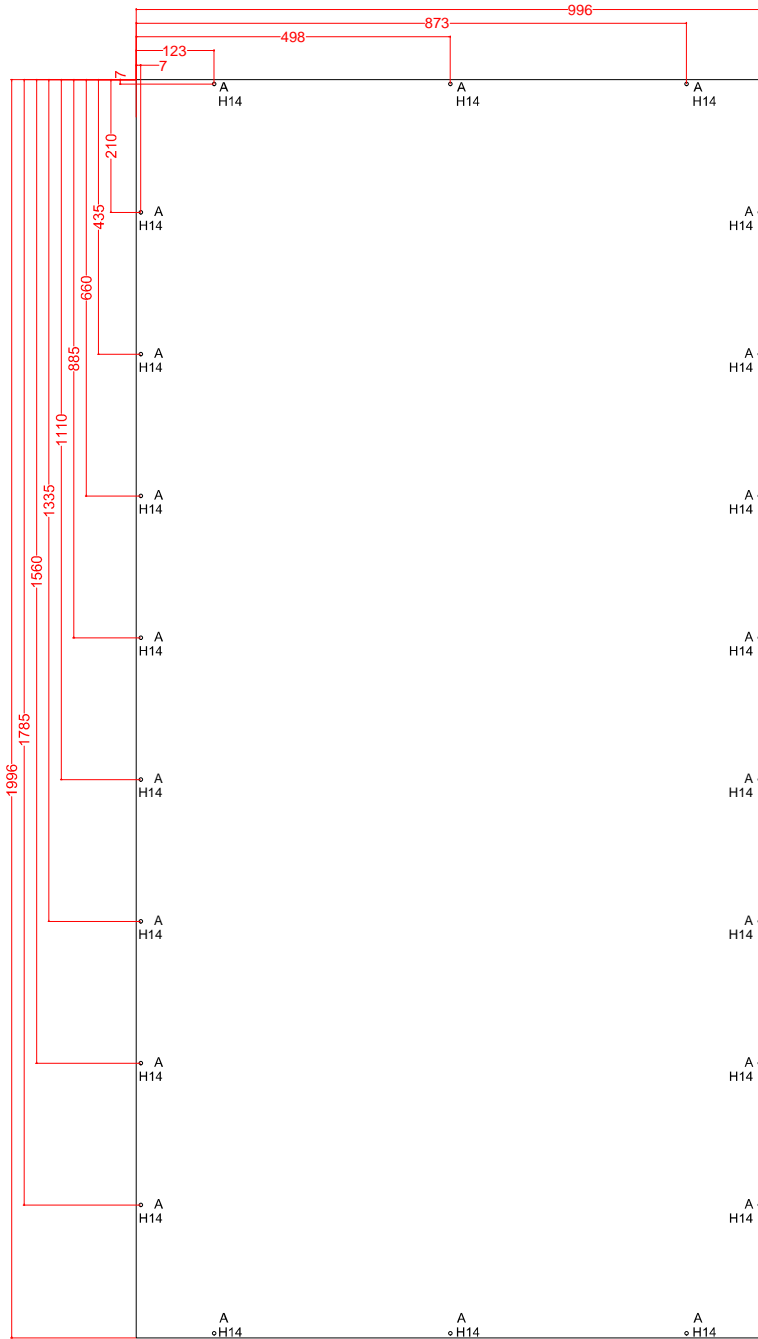

SCREW HEADS

H14	22
-----	----

PERFORATION

A	5	PASS
---	---	------

Hiddenbed™

PATENTED SYSTEM
© HIDDENBED 2003

CONFIDENTIAL DRAWINGS
ALL REPRODUCTION PROHIBITED

Date: 12/11/2020

TD 83 AT 1000 x 2000 CPU

MANUFACTURING DATA
FICHA FABRICACIÓN

DATE FECHA	COMPANY NAME EMPRESA
CITY CIUDAD	COMPANY CONTACT CONTACTO FABRICA
ADDRESS DIRECCION	EMAIL
TEL	RESPONSABLE R&D

PICTURES
IMAGENES