

# Hiddenbed ™

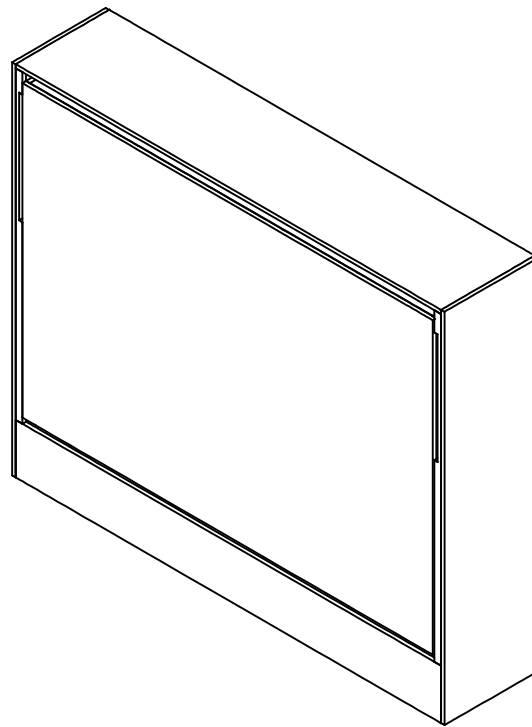
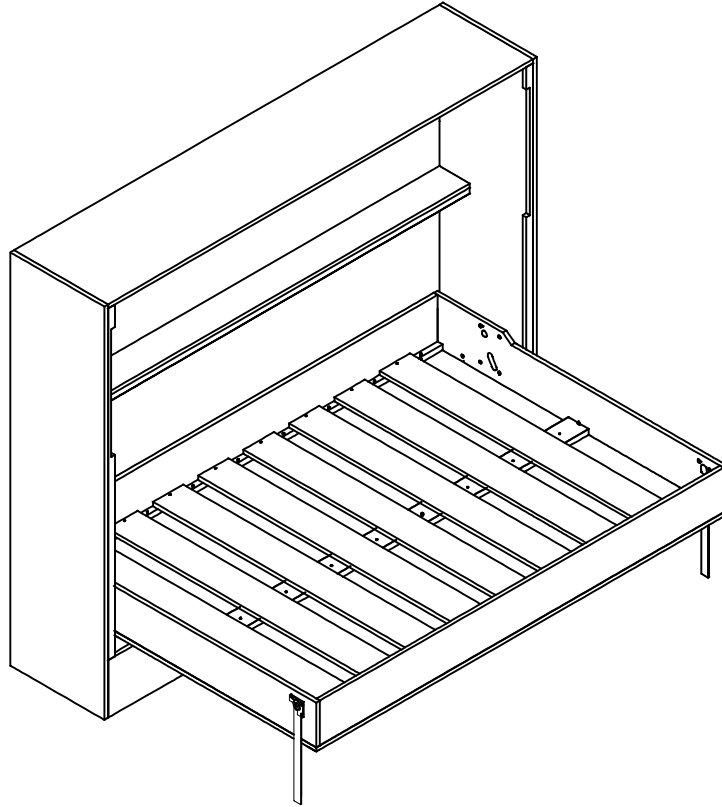

ATTRACTIVE  
1400 X 2000

# PRODUCTION DRAWINGS - MODEL ATTRACTIVE

## TD 51 AH 1400 X 2000 PNU

All rights reserved.

Important Measurements (unit: milimeters)	Longitudinal Parts Lenght Largo Partes Longitudinales	
	Mattress lodge Alojamiento colchón 2000 x 1400	Mattress Support Soporte Colchón
Bedrail Thickness 2 x 18 Espesor Largueros		36
Mechanism Clearance Luz para Mecanismo 36 x 2		72
Shelves Estantes		2108
Low Stretcher Separador Inferior		2108

### Drawings Index Indice de Planos

A - Parts List: Body and Bed	/	Lista de Partes: Body y Bed
B - Close Position	/	Posición Cerrada
C - Bed Position	/	Posición Cama
S - Furniture Screws	/	Tornillos para el Mueble
M - Mechanism	/	Mecanismo



Technical drawing suggested.  
They may change according to national safety regulations.  
Manufacturer must assure the correct assembly of all parts.  
Remember! reference for drilling are centers.

Planos sugeridos.  
Pueden cambiar según las normas nacionales de seguridad.  
El fabricante debe asegurar el correcto ensamblaje de las partes.  
Nota! la referencia de las perforaciones es a los centros.

**Body Parts List/ Lista de partes**

Part N° N° de Pieza	Name Nombre	Qty. Cant.
1	Body Side L/R	2
2	Concealer	2
3	Bottom Stretcher	1
4	Body Top	1
5	Shelf	2
6	Shelf Stretcher	2
7	Bed Stop	2

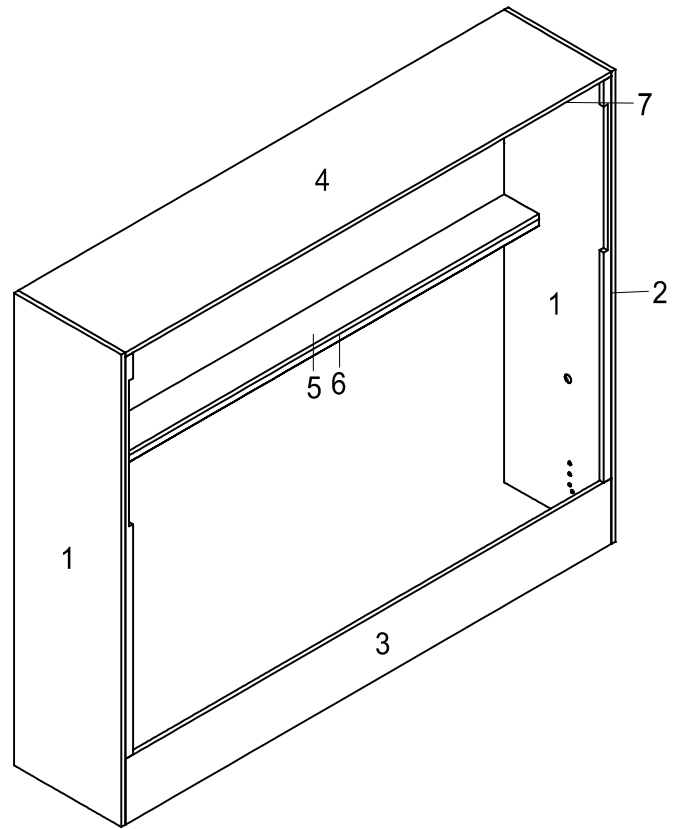

**Bed Parts List/ Lista de partes**

8	Bed Side	2
9	Bed Left	1
10	Bed Right	1
11	Sides Cleats	2
12	Bed Slats	8
13	Cover	1
14	Side Cleat B	1

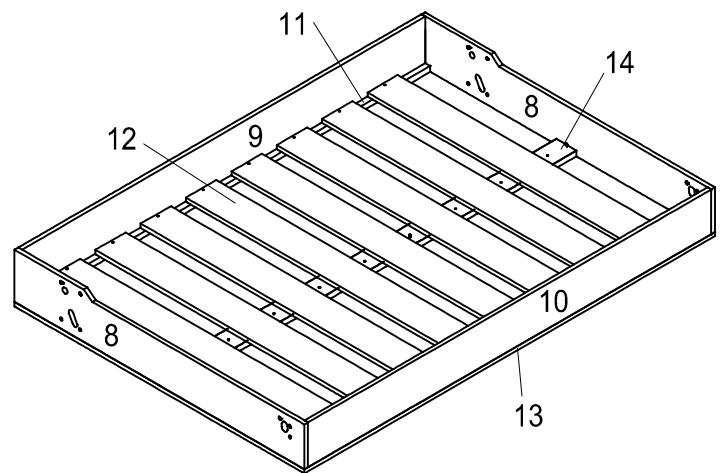

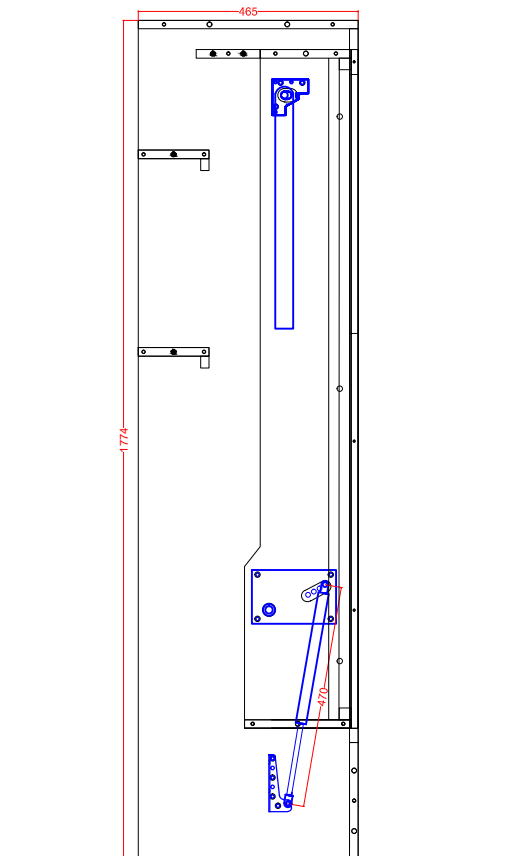
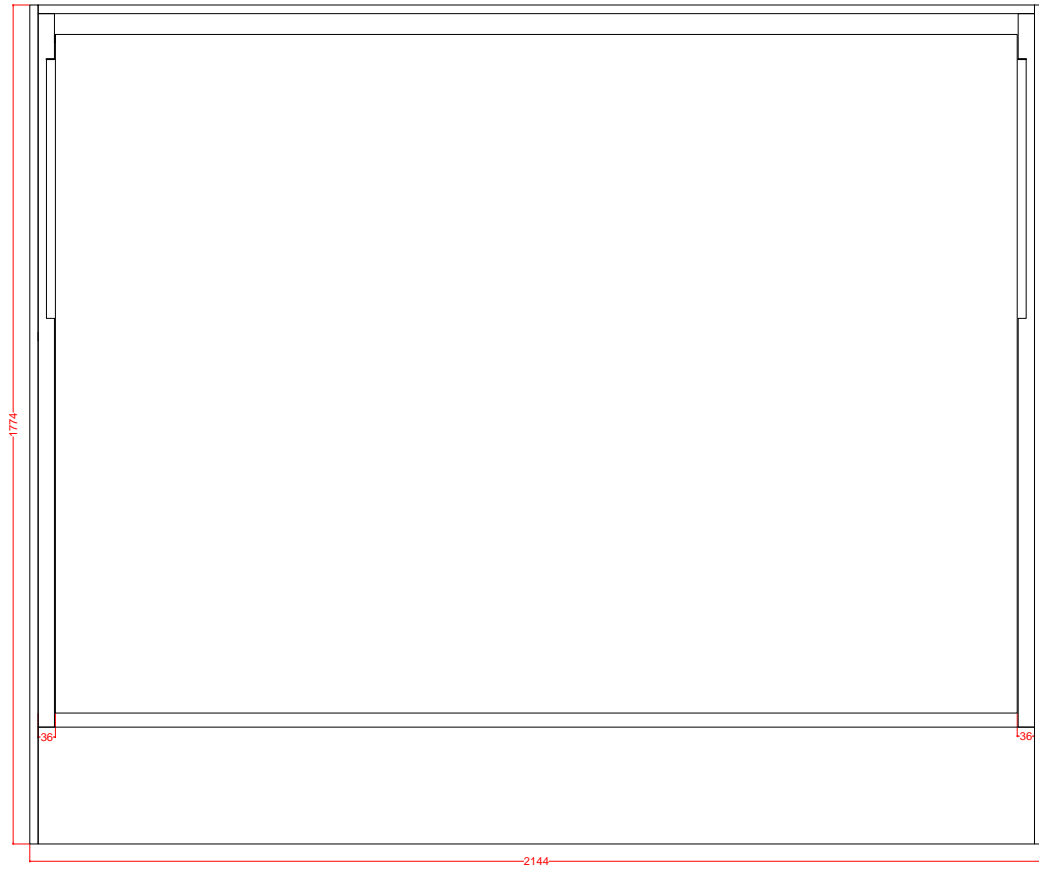





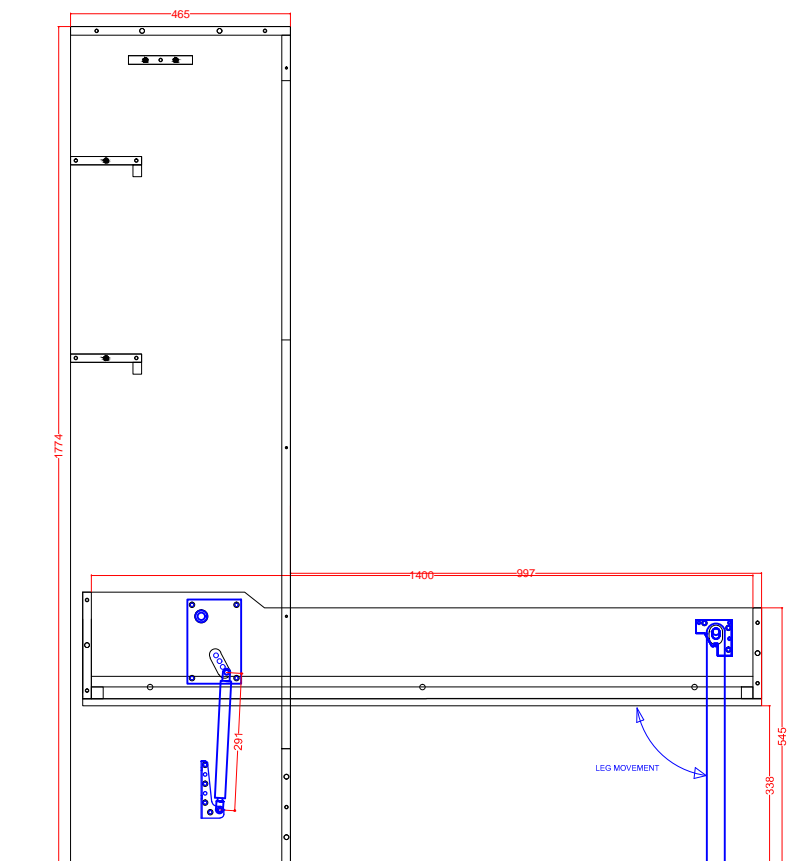
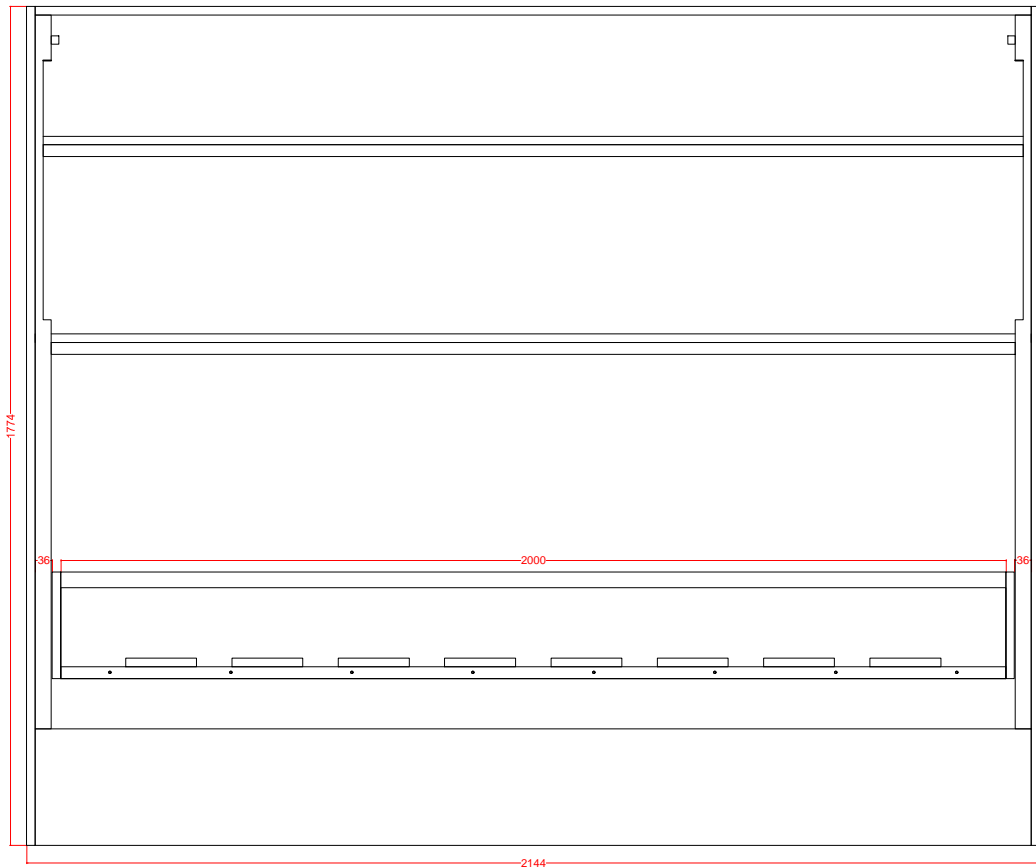



# BED POSITION



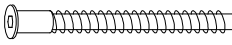

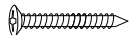

TD 51 AH 1400 X 2000 PNU



Manufacturer to verify adequate drilling diameter and depth for screw or dowel length in every place.  
 El fabricante deberá verificar el adecuado diámetro y profundidad de las perforaciones para cada tornillo o tarugo.

-  Drill to drive a screw position
-  Drill for screw through position.

Name	Code	Dimension	Quantity	Sketch
Confirmat	H2	7 x 70	22	
Flat Head Allen & T nut	H11	6 x 15	16	
Screw, Ph Head	H14	4,5 x 35	75	
Round Head Allen & T nut	H12	6 x 30	6	
Dowel 10 x 30 mm		10 x 30	20	
Minifix	H44	REFERENCE HAFFLE'S 262.27.029 / 262.17.710	12	

Drawing	Screw	Quantity
1	H2	14
	H11	8
	H14	2
2	H44	6
3		4
4		4
5		4
6	H14	14
7		4
8	H2	8
	H12	6
	H11	8
9		2
10		2
11	H14	16
12	H14	16
13	H14	27
	H44	6
14	----	----
<b>TOTAL</b>		<b>151</b>

Bed Position

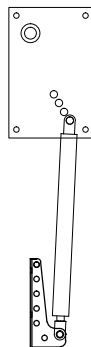

Close Position

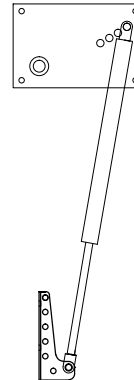

# MECHANISM FIXING

S2 SCREWS RESUME:  
(INCLUDED IN S1)

## Carapaces

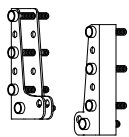

Name	Code	Dimension	Quantity	Sketch
Flat Head Allen & T nut	H11	6 x 15	8	

## Mech Plate

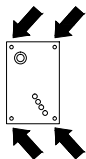

Name	Code	Dimension	Quantity	Sketch
Flat Head Allen & T nut	H11	6 x 15	8	

## Leg



Name	Code	Dimension	Quantity	Sketch
Round Head Allen & T nut	H12	6 x 30	6	

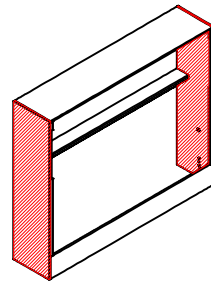

Part: Body Side (1)  
 Material: MDF  
 Thick: 18mm  
 Quantity: 2

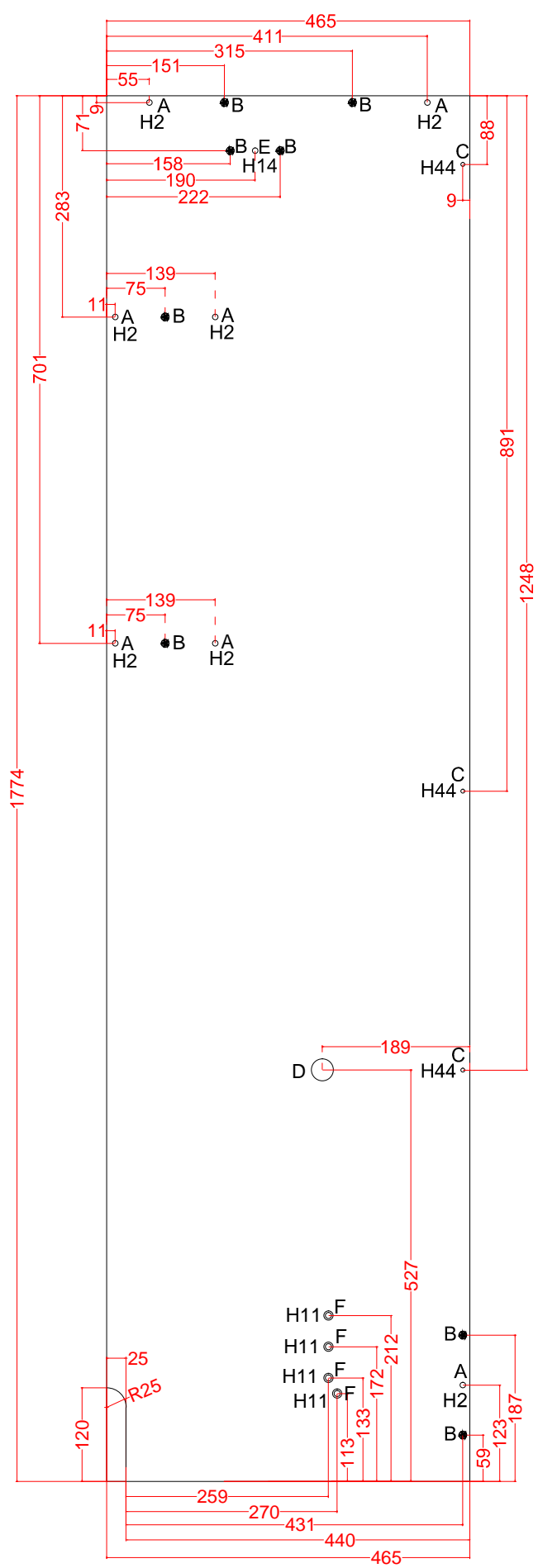

SCREW HEADS

H2	7 x 2
H11	4 x 2
H14	1 x 2

PERFORATION

A	7	PASS
B	10	10
C	5	12
D	28	PASS
E	5	PASS
F	8	13
Milling	12	2

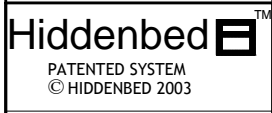

CONFIDENTIAL DRAWINGS  
 ALL REPRODUCTION PROHIBITED

Date: 18/11/2020  
 TD 51 AH 1400 X 2000 PNU



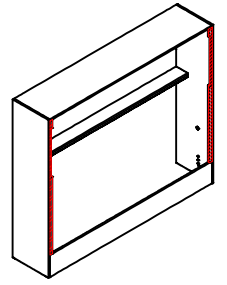

Part: Concealer (2)

Material: MDF

Thick: 18mm

Quantity: 2

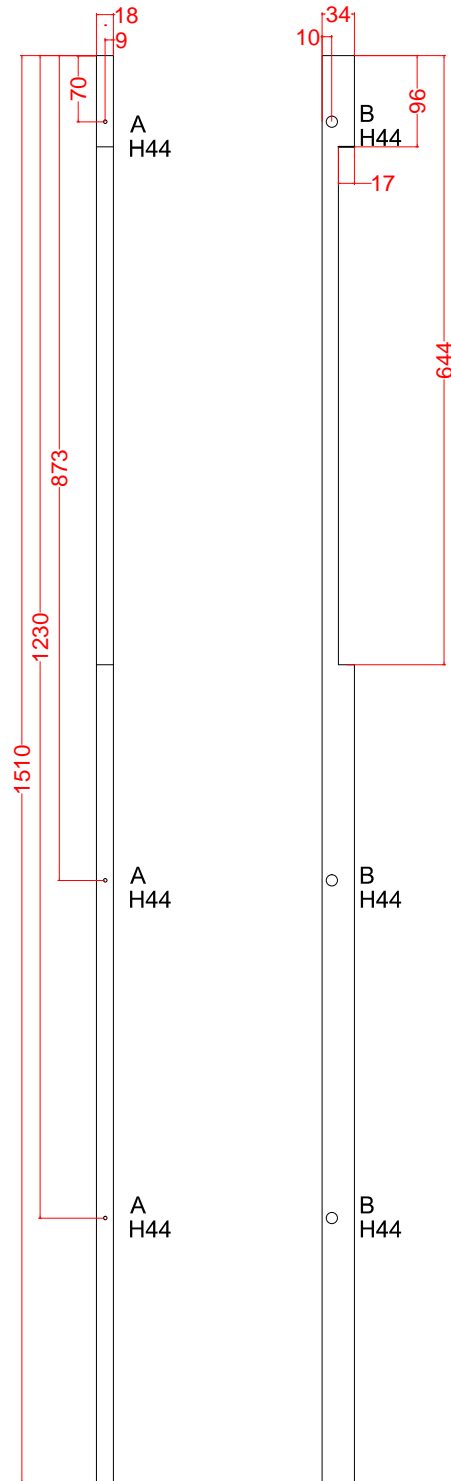

SCREW HEADS

H44 3 x 2

PERFORATION

	A	B
12	10,2	
8	24	

**Hiddenbed**™  
PATENTED SYSTEM  
© HIDDENBED 2003

CONFIDENTIAL DRAWINGS  
ALL REPRODUCTION PROHIBITED

Date: 18/11/2020

TD 51 AH 1400 X 2000 PNU

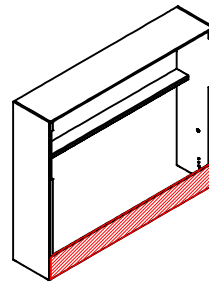

Part: Bottom Stretcher(3)

Material: MDF

Thick: 18mm

Quantity: 1

SCREW HEADS



4

PERFORATION

A	5.5	70
B	10	22

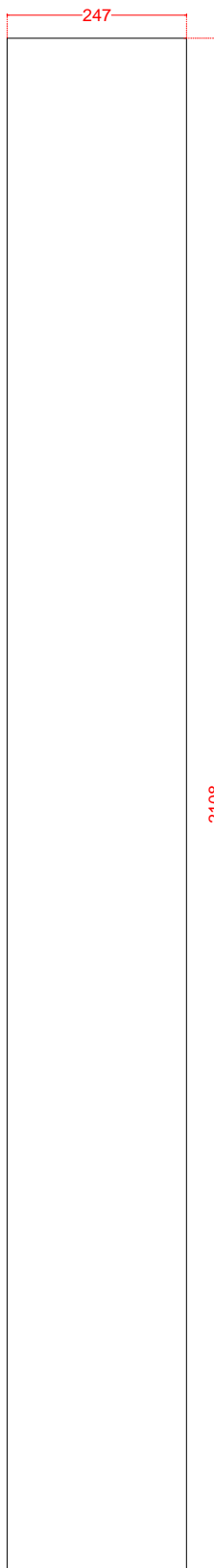

**BOTH ENDS  
AMBOS EXTREMOS**

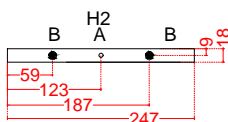

**Hiddenbed**  <sup>TM</sup>

PATENTED SYSTEM  
© HIDDENBED 2003

CONFIDENTIAL DRAWINGS  
ALL REPRODUCTION PROHIBITED

Date: 18/11/2020

TD 51 AH 1400 X 2000 PNU

TD 51 AH 1400 X 2000 PNU

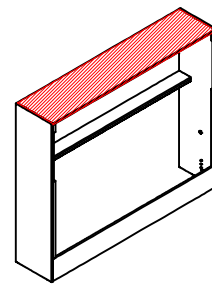

Part: Body Top (4)  
 Material: MDF  
 Thick: 18mm  
 Quantity: 1

SCREW HEADS



PERFORATION

A	5.5	70
B	10	22

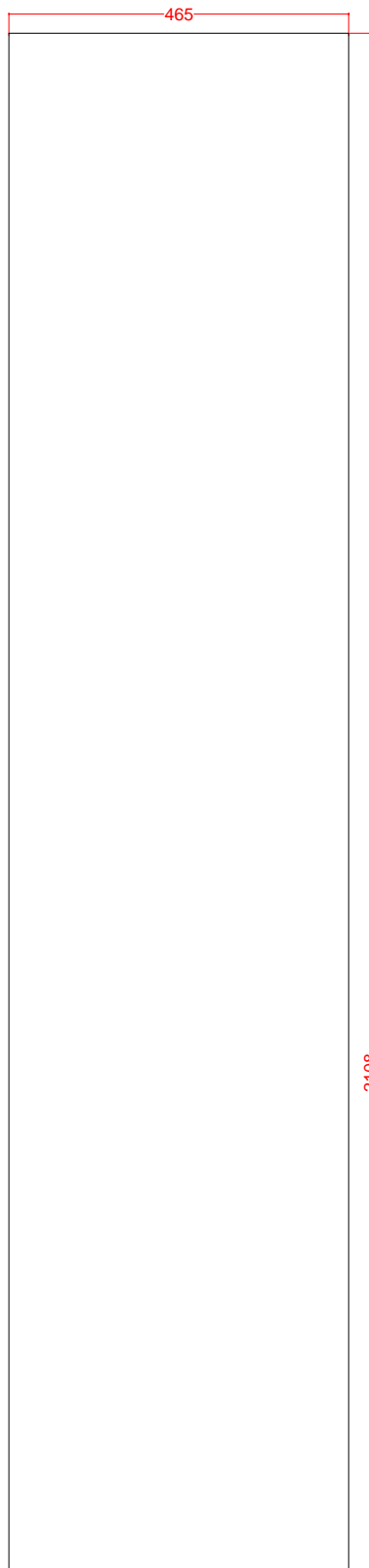

BOTH ENDS  
 AMBOS EXTREMOS

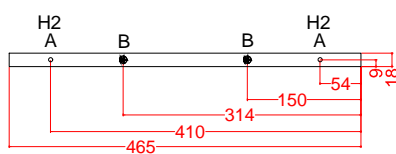

**Hiddenbed**<sup>TM</sup>  
 PATENTED SYSTEM  
 © HIDDENBED 2003

CONFIDENTIAL DRAWINGS  
 ALL REPRODUCTION PROHIBITED

Date: 18/11/2020

TD 51 AH 1400 X 2000 PNU

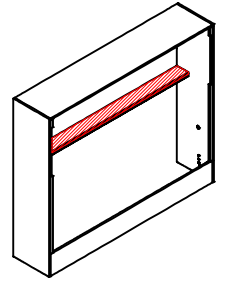

Part: Shelf (5)

Material: MDF

Thick: 18mm

Quantity: 2

SCREW HEADS



2 x 2

PERFORATION

A	5.5	70
B	10	22
C	3	2

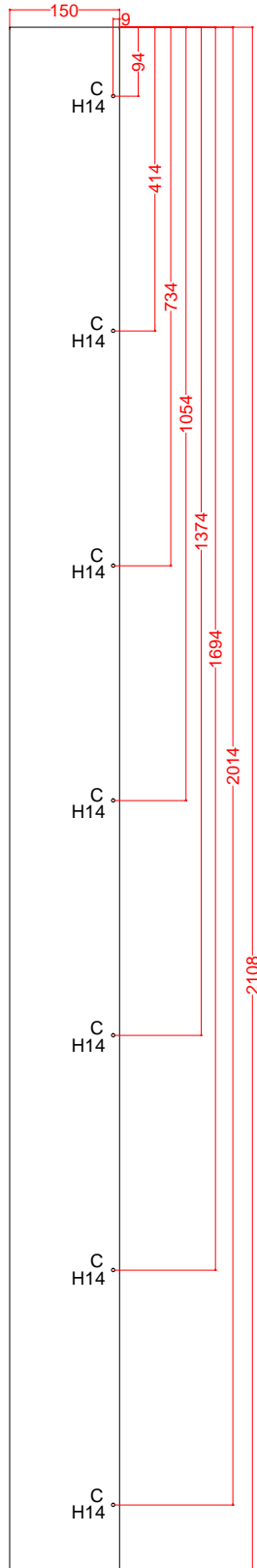

BOTH ENDS  
AMBOS EXTREMOS

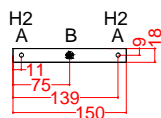

Hiddenbed <sup>TM</sup>

PATENTED SYSTEM  
© HIDDENBED 2003

CONFIDENTIAL DRAWINGS  
ALL REPRODUCTION PROHIBITED

Date: 18/11/2020

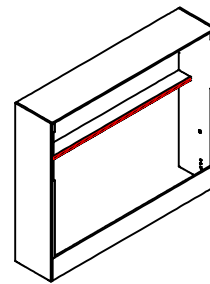

Part: Shelf Stretcher(6)  
 Material: MDF  
 Thick: 18mm  
 Quantity: 2B

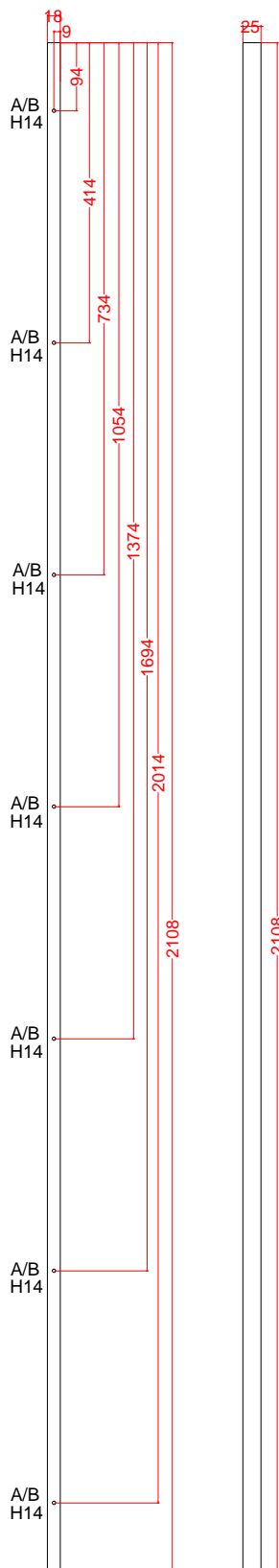

A perforations are for one stretcher  
 Stretcher for body top is screwed downwards



B perforations are for two other stretchers  
 which need to be screwed on this piece  
 Stretchers for Shelves are screwed upwards

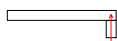

SCREW HEADS

H14 7 x 2

PERFORATION

A	3	2
B	5	PASS

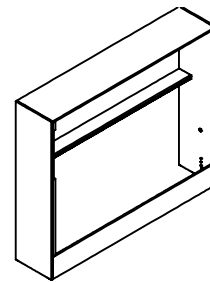

Part: Bed Stop (7)

Material: MDF

Thick: 18mm

Quantity: 2

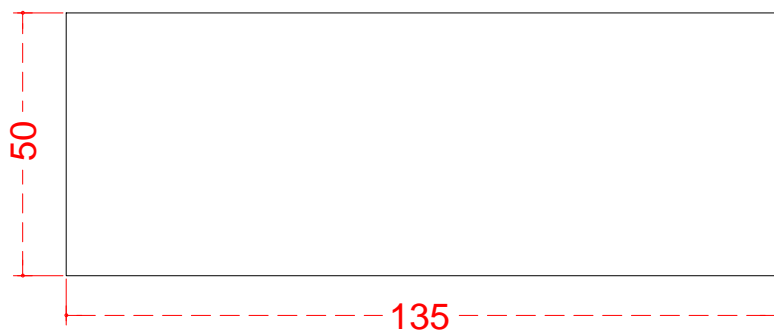
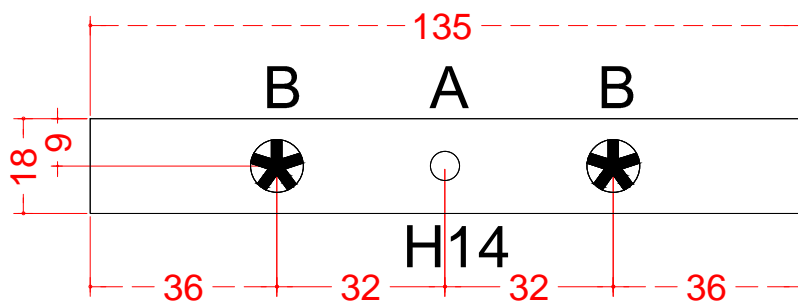

SCREW HEADS



2 x 2

PERFORATION

A	3	2
B	10	22

Hiddenbed  <sup>TM</sup>  
 PATENTED SYSTEM  
 © HIDDENBED 2003

CONFIDENTIAL DRAWINGS  
 ALL REPRODUCTION PROHIBITED

Date: 18/11/2020

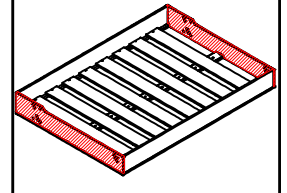

FRONT



FOR LEG  
on the outside

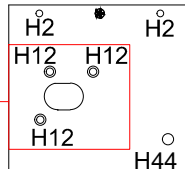

H44

TOP



H44

H44

FOR PLATE  
on the outside

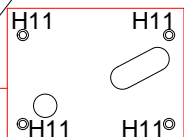

H44



H44

SCREW HEADS

H2 4 x 2

H12 3 x 2

H11 4 x 2

PERFORATION

Hiddenbed

PATENTED SYSTEM  
© HIDDENBED 2003

CONFIDENTIAL DRAWINGS  
ALL REPRODUCTION PROHIBITED

Date: 18/11/2020

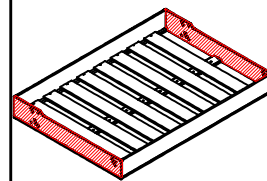

Part: Bed Side (8)

Material: MDF

Thick: 18mm

Quantity: 2

SCREW HEADS

PERFORATION

	A	7	PASS
	B	10	10
	C	25	12
	D	28	5
	E	8	PASS
Milling		12	2
	F	8	24
	G	12	10,2

FRONT

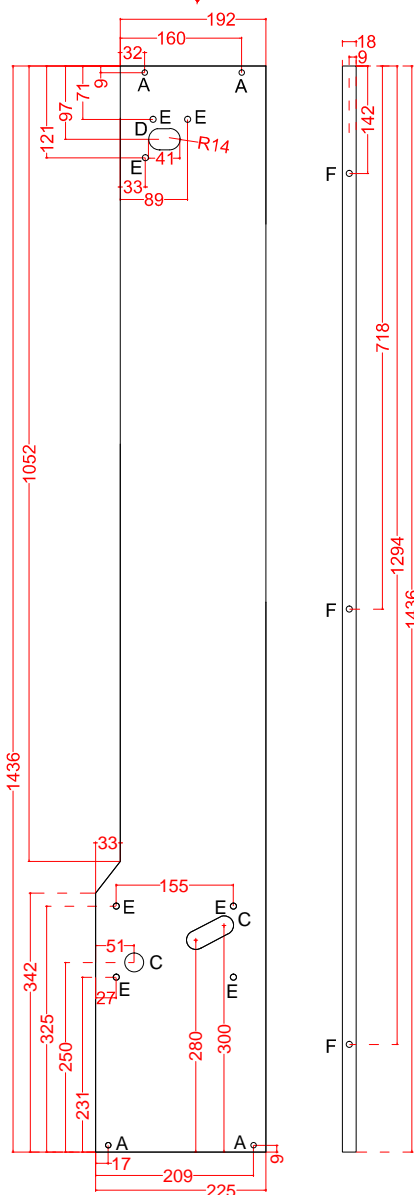

OUTSIDE VIEW  
VISTA EXTERIOR

FRONT

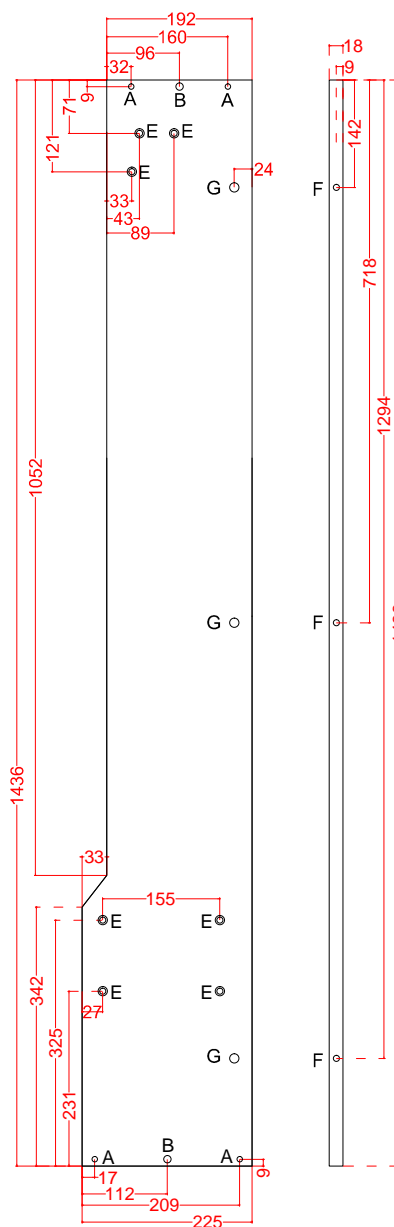

INSIDE VIEW  
VISTA INTERIOR

**Hiddenbed**™

PATENTED SYSTEM  
© HIDDENBED 2003

CONFIDENTIAL DRAWINGS  
ALL REPRODUCTION PROHIBITED

Date: 18/11/2020



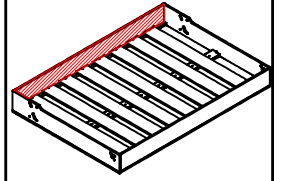

Part: Bed Left (9)

Material: MDF

Thick: 18mm

Quantity: 1

SCREW HEADS

	2
---	---

PERFORATION

A	5.5	70
B	10	22
C	3	2

TOP 

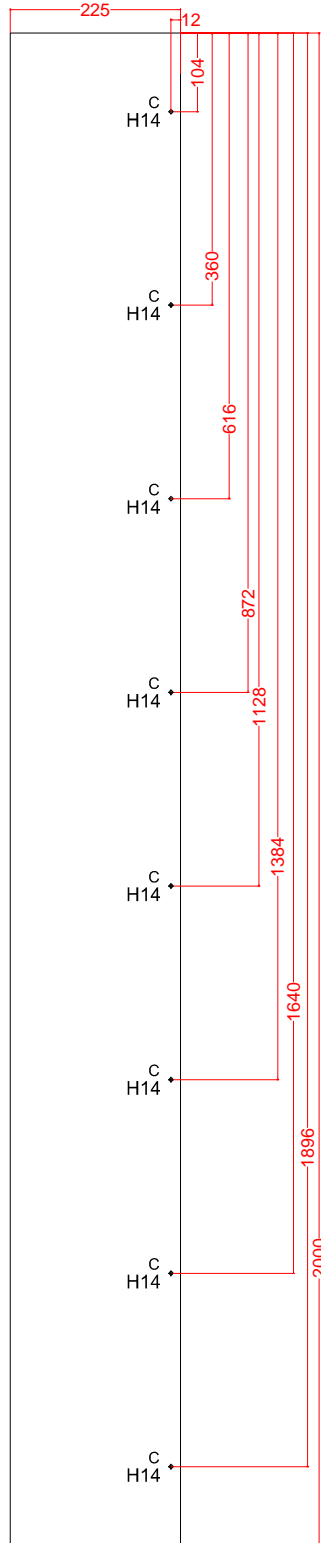

BOTH ENDS  
AMBOS EXTREMOS

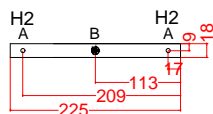

**Hiddenbed** 

PATENTED SYSTEM  
© HIDDENBED 2003

CONFIDENTIAL DRAWINGS  
ALL REPRODUCTION PROHIBITED

Date: 18/11/2020

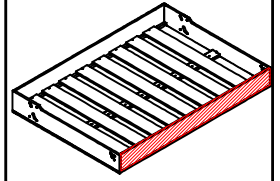

Part: Bed Right (10)

Material: MDF

Thick: 18mm

Quantity: 1

SCREW HEADS

	2
---	---

PERFORATION

A	5.5	70
B	10	22
C	3	2

**Hiddenbed** 

PATENTED SYSTEM  
© HIDDENBED 2003

CONFIDENTIAL DRAWINGS  
ALL REPRODUCTION PROHIBITED

Date: 18/11/2020

TOP 

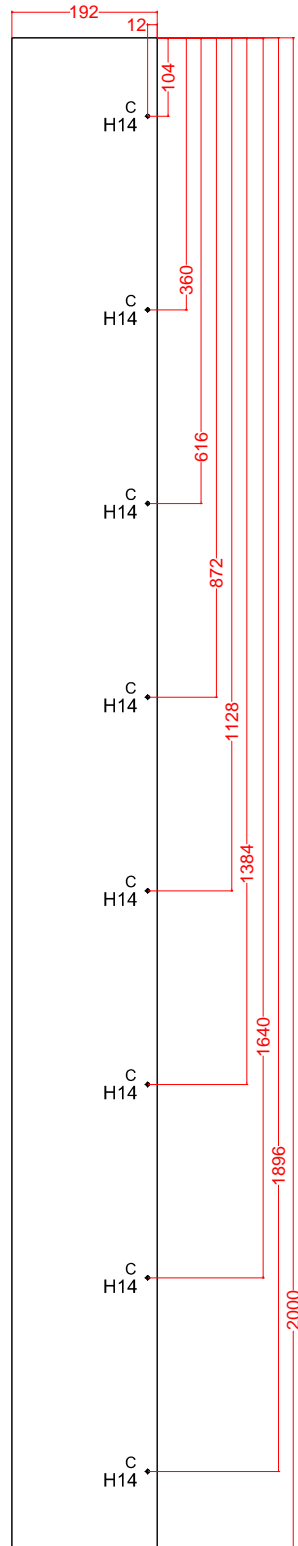

BOTH ENDS  
AMBOS EXTREMOS

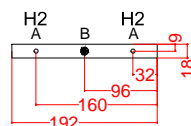

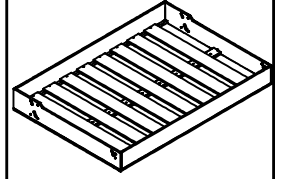

Part: Slats Cleats (11)

Material: MDF

Thick: 25mm

Quantity: 2

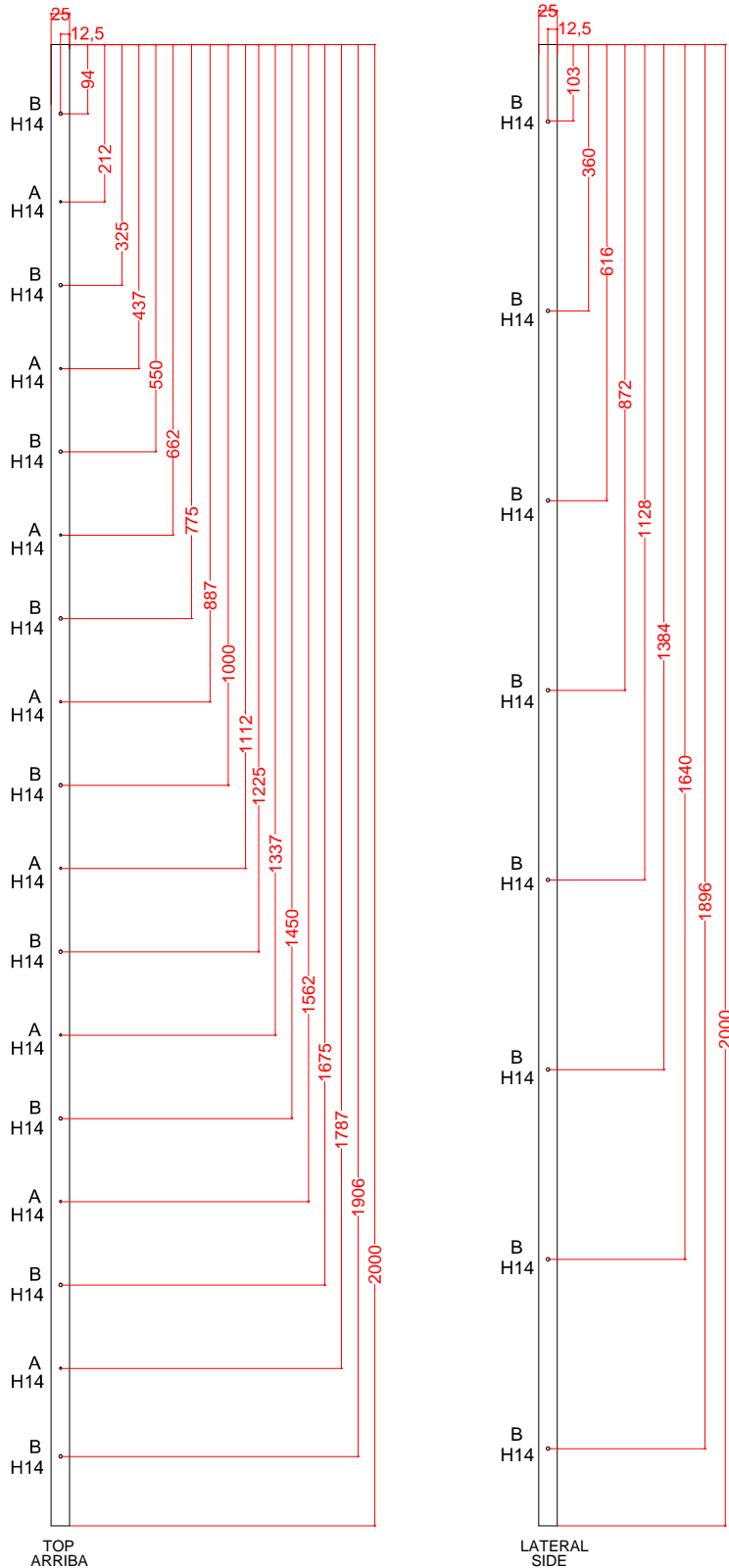

SCREW HEADS

H14	8 x 2
-----	-------

PERFORATION

A	3	2
B	5	PASS

**Hiddenbed**™  
 PATENTED SYSTEM  
 © HIDDENBED 2003

CONFIDENTIAL DRAWINGS  
 ALL REPRODUCTION PROHIBITED

Date: 18/11/2020

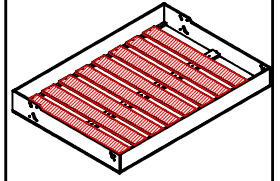

Part: Bed Slats (12)

Material: MDF

Thick: 18mm

Quantity: 8

SCREW HEADS

H14	2 x 8
-----	-------

PERFORATION

A	5	PASS
---	---	------

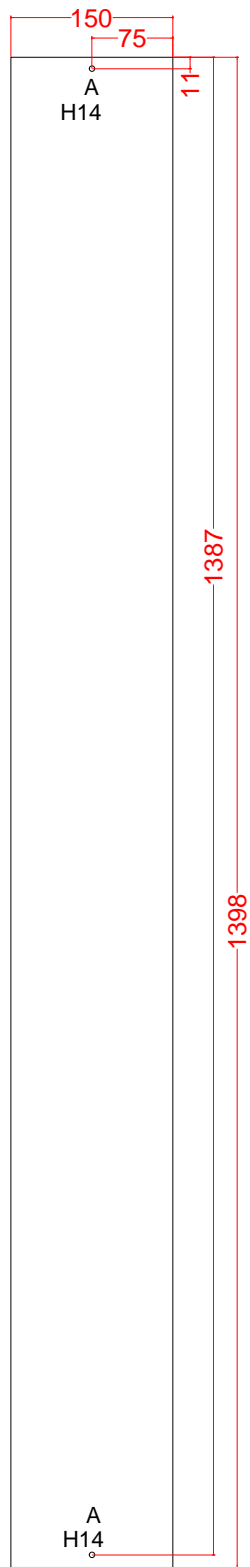

**Hiddenbed**  <sup>TM</sup>  
 PATENTED SYSTEM  
 © HIDDENBED 2003

CONFIDENTIAL DRAWINGS  
 ALL REPRODUCTION PROHIBITED

Date: 18/11/2020

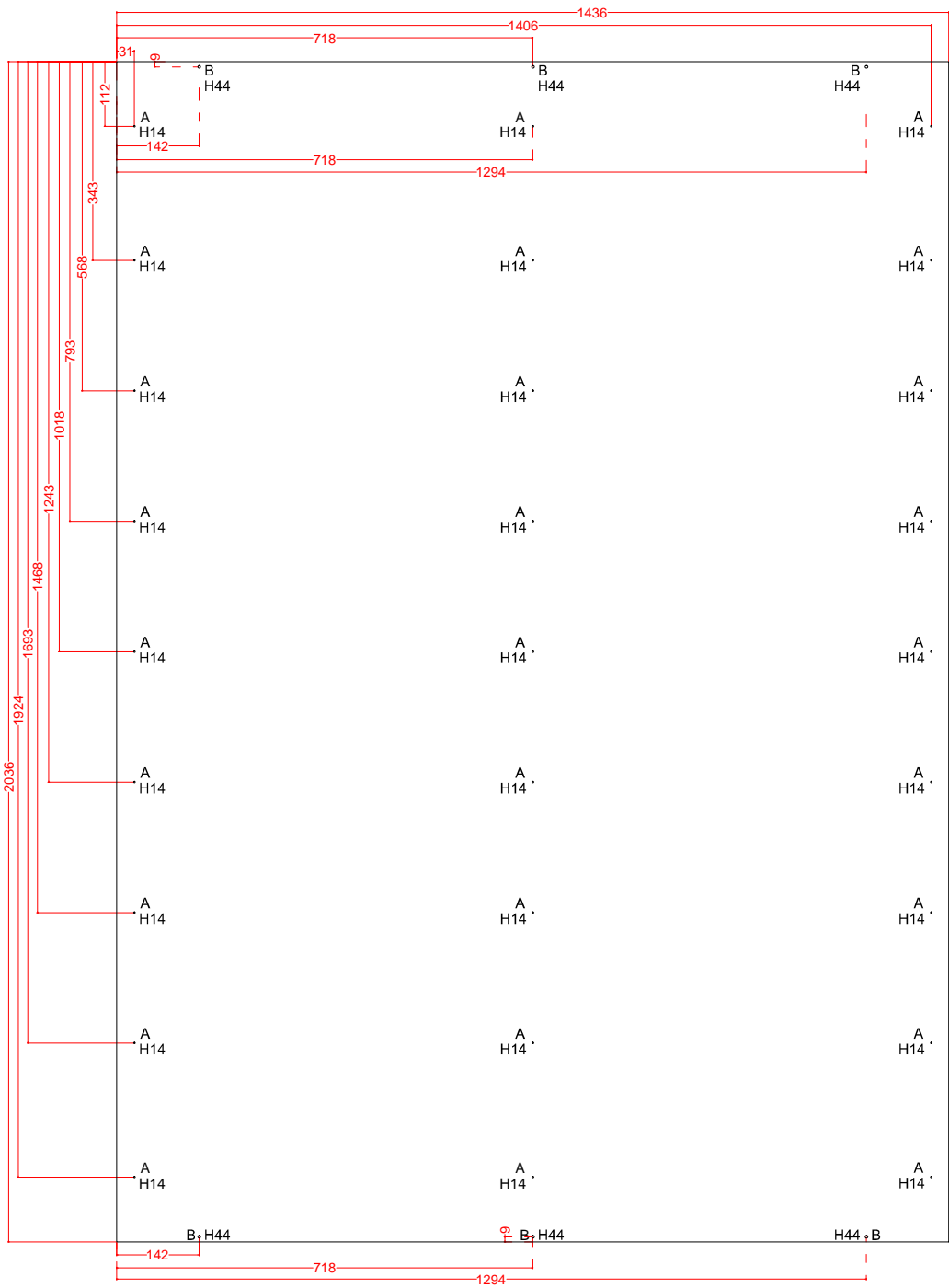
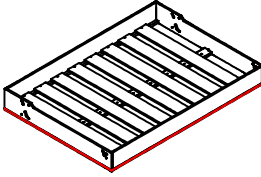

Part: Cover (13)  
 Material: MDF  
 Thick: 15mm  
 Quantity: 1

SCREW HEADS	
H14	27
H44	6

PERFORATION		
A	3	2
B	5	12

**Hiddenbed**™  
 PATENTED SYSTEM  
 © HIDDENBED 2003

CONFIDENTIAL DRAWINGS  
 ALL REPRODUCTION PROHIBITED

Date: 18/11/2020

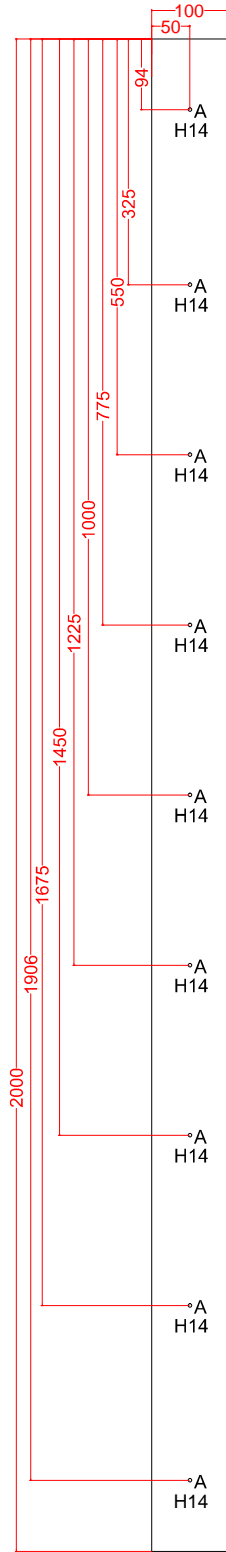

TD 51 AH 1400 X 2000 PNU

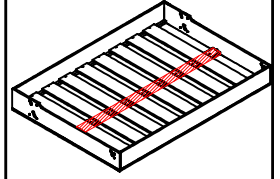

Part: Slat Cleats B (14)

Material: MDF

Thick: 25mm

Quantity: 1

SCREW HEADS		

PERFORATION		
A	5	PASS

**Hiddenbed**™  
 PATENTED SYSTEM  
 © HIDDENBED 2003  
 CONFIDENTIAL DRAWINGS  
 ALL REPRODUCTION PROHIBITED  
 Date: 18/11/2020  
 TD 51 AH 1400 X 2000 PNU

MANUFACTURING DATA  
FICHA FABRICACIÓN

DATE FECHA	COMPANY NAME EMPRESA
CITY CIUDAD	COMPANY CONTACT CONTACTO FABRICA
ADDRESS DIRECCION	EMAIL
TEL	RESPONSABLE R&D

PICTURES  
IMAGENES