

LamiFIX[®]

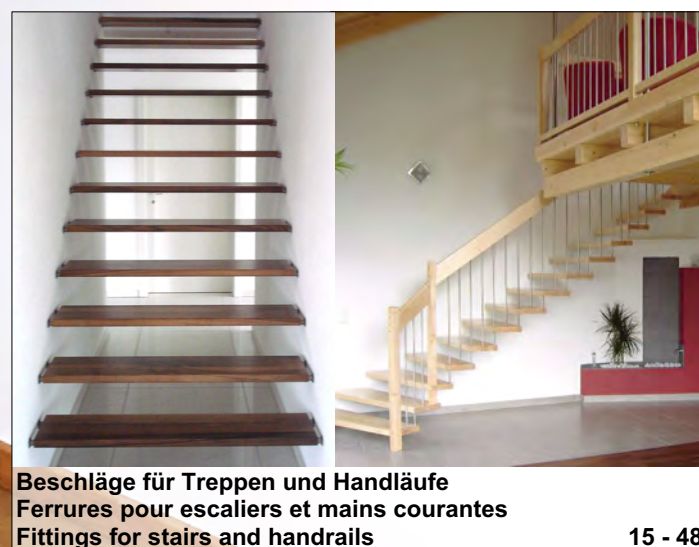

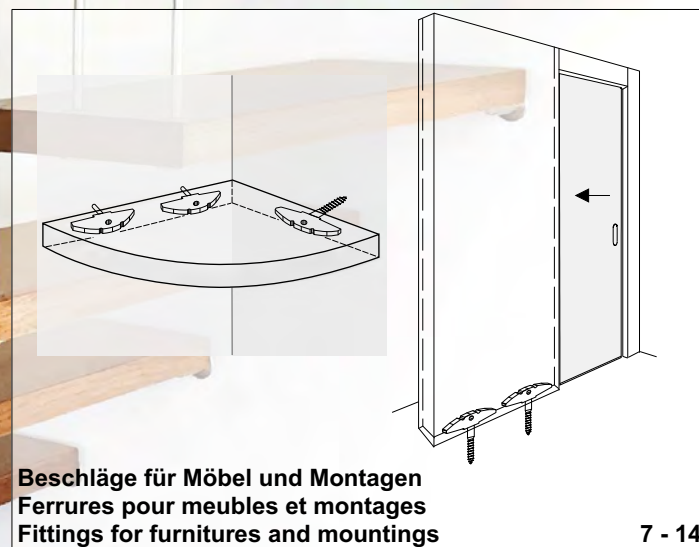

Pat. Internat. 2016/17

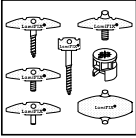
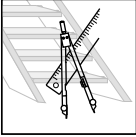

Treppenfotos:
Photos d'escaliers:
Stair photos:

www.lamifix.ch

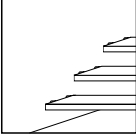
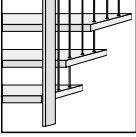

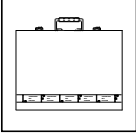
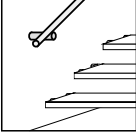
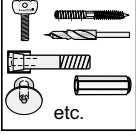
| | | |
|---|--|----------|
|  | <p>Inhaltsverzeichnis Sommaire Index</p> | <p>0</p> |
|  | <p>Beschläge für Möbel + Montagen Ferrures pour meubles et montages Fittings for furnitures + mountings</p> | <p>1</p> |
|  | <p>Technik + Statik für Treppen Technique + statique pour escaliers Technique + statics for stairs</p> | <p>2</p> |
|  | <p>CAD-Planung, Plot Planification CAO, plans CAD-engineering, plots</p> | <p>3</p> |
|  | <p>Stufenbefestigungen seitlich, Montageanleitung Fixations latérales des marches, instructions de montages Lateral step fixations, mounting instructions</p> | <p>4</p> |
|  | <p>Stufenaufhängungen Ø10 + Ø16, Montageanleitungen, Zuschnittlisten, Pfostenverschraubung Suspensions des marches Ø10 + Ø16, instructions de montages, listes de coupe, vissage pour pilier Hanger for steps Ø10 + Ø16, mounting instructions, cutting lists, pile-screwing</p> | <p>5</p> |
|  | <p>Antirutschbänder, Zentrumsschraube für Spindeltreppen Bande antidérapant, vis centrale pour escalier en colimaçon Anti-slip tape, center screw for spiral stairs</p> | <p>6</p> |
|  | <p>Montagekoffer für Treppen Coffret de montage pour escaliers Toolbox for stairs</p> | <p>7</p> |
|  | <p>Handlaufbeschläge Ferrures pour mains courantes Fittings for handrails</p> | <p>8</p> |
|  | <p>Einzelteile + Diverses Pièces détachées + divers Single items + miscellaneous etc.</p> | <p>9</p> |

A

| | |
|-------------------|------------|
| Abdeckhülsen | 46 |
| Abdeckkappen | 10 / 44 |
| Anker | 19-30 / 46 |
| Anreisser | 11 |
| Anschlag | 33 / 44 |
| Anschraubring | 29 / 45 |
| Anschraubrossette | 29 / 45 |
| Antirutschband | 41 / 48 |
| Aufhängung | 30-40 |
| Avor-Listen | 32 / 37 |

B

| | |
|------------------|-------------------|
| Bankeisen | 7 / 12 |
| Bit | 11 / 46 |
| Bodenträger | 8 |
| Bohrbüchsen | 11 / 29 / 45 / 46 |
| Bohrer | 11 / 29 / 39 / 45 |
| Bohrverlängerung | 39 / 45 |
| Bohrschablonen | 13 / 29 / 45 |
| Bolzen | 19-27 / 46 / 47 |
| Bundmutter | 39 / 47 |

C

| | |
|--------------|----|
| CAD-Planung | 17 |
| Chemiemörtel | 45 |

D

| | |
|------------------------|-----------------|
| Dämpfungshülsen | 34 / 47 |
| Dämpfungsringe | 34 / 47 |
| Deckrosetten | 30-36 / 47 / 48 |
| Distanzringe | 26 / 46 |
| Doppelverbinder | 9 |
| Dübelbohrschablone DMC | 13 |

E

| | |
|-------------------------|--------------|
| Eindrehwerkzeug | 11 / 44 / 46 |
| Einschlagtopf | 46 |
| Einstellehren für (DMC) | 13 |
| Endrosetten | 30 / 34 / 47 |
| Endschrauben | 11 |
| Euroverbinder | 8 |
| Exzenter | 10 |

F

| | |
|-----------------------------|---------|
| Fachbodenträger | 8 |
| Fräser | 29 / 46 |
| Führungshülse / Bohrbüchsen | 29 / 45 |

G

| | |
|--------------------------|-----------------|
| Gehrungsschablone | 9 / 13 |
| Gehrungsverbinder | 9 |
| Geländerstäbe | 30-37 / 47 / 48 |
| Gewindemuffen | 11 / 30-34 / 34 |
| Gewindestangen | 34-37 / 44 |
| Gewindestifte | 44 |
| Gewindeverlängerungen | 44 |
| Glasbefestigungsschraube | 43 |
| Glaspunkthalter | 27 / 48 |
| Grundsortiment | 7-14 |

H

| | |
|----------------------|--------------|
| Handlaufstützen | 43 / 48 |
| Hängeelemente | 30-40 |
| Heftseisen | 7-12 |
| Höhenausgleich | 34-37 / 47 |
| Hülsen | 11 / 46 / 47 |
| Holzgewindeverbinder | 7 / 8 / 12 |

I

| | |
|--------------------|-----------------|
| Innengewindehülsen | 11 / 44 / 45 |
| Injektionsmörtel | 45 |
| Inox-Rohre | 34-37 / 47 |
| Inox-Stangen | 30-32 / 47 / 48 |

J

| | |
|-----------------|------------|
| Justierscheiben | 22-25 / 46 |
|-----------------|------------|

K

| | |
|---------------------------|---------|
| Kartuschenmörtel | 45 |
| Klebebänder | 41 / 48 |
| Koffer mit Grundsortiment | 14 |
| Koffer für den Treppenbau | 42 |
| Kupplung | 35 / 44 |

L

| | |
|---------------------------|-------------------|
| Lamellenverbinder | 7-14 / 19-26 / 44 |
| Listen für Zuschnittmasse | 32 / 37 |

M

| | |
|---------------------|-----------------|
| Markierspitzen | 11 |
| Metrische Verbinder | 8 / 12 / 44 |
| Möbelverbinder | 7-14 |
| Montageanker | 22-25 / 43 / 45 |
| Montageanleitungen | 28 / 31 / 35 |
| Montagekoffer | 14 / 42 |
| Montageverbinder | 7-14 / 19-27 |
| Mörtel | 45 |

N

| | |
|-------------|---------|
| Normen | 15 / 16 |
| Nutfräser | 29 |
| Nylonmuffen | 11 |

O

| | |
|---------|---------|
| O-Ringe | 34 / 47 |
|---------|---------|

P

| | |
|----------------------|---------|
| Pfostenverschraubung | 38 / 48 |
| Presswerkzeug | 44 |

R

| | |
|--------------|---------------|
| Ratschensatz | 46 |
| Rohranschlag | 33-35 / 44 |
| Rohre | 34-37 / 47 |
| Rosetten | 21-36 / 45-48 |
| Rundmutter | 38 / 39 / 47 |
| Rundstäbe | 46 |

SCH

| | |
|-------------------------------|-------------------|
| Schablonen | 13 / 29 / 39 |
| Schallschutzdübel | 23-35 / 45 |
| Schrauben | 11 / 39 / 43 / 44 |
| Schraubensicherung mittelfest | 47 |

S

| | |
|-----------------------------|--------------|
| Seitliche Stufenbefestigung | 19-29 |
| Seele für Spindeltreppe | 41 |
| Set für Treppen | 19-38 |
| Siebhülsen | 22 / 25 / 45 |

ST

| | |
|--------------------------|-----------------|
| Stahlmuffen | 11 / 30-34 / 44 |
| Stahlwangenenelemente | 26 |
| Staketenbohrlehre | 39 / 48 |
| Staketenrohre | 34 / 37 |
| Stangen Inox geschliffen | 30 / 48 |
| Stangenschablone (DMC) | 13 |
| Statik | 15 |
| Stirnlochschlüssel | 39 / 47 |
| Stockschrauben | 39 / 44 |
| Stockschraubeneindreher | 39 / 44 |
| Stopfen für Rundmutter | 39 / 47 |
| Stufenaufhängungen | 30-40 |
| Stufenbohrer | 39 / 45 |

T

| | |
|---------------------------|-----------------|
| Tablarträger | 8 |
| Tiefenanschlag für Bohrer | 11 / 45 |
| Topf zum Einschlagen | 46 |
| Tragrosetten | 30-34 / 47 / 48 |
| Treppenschrauben | 39 / 47 |
| Treppenbolzen | 19-27 / 46 |
| Treppenkoffer | 42 |
| Treppensortiment | 15-48 |

U

| | |
|----------------|----|
| Umschaltknarre | 46 |
|----------------|----|

V

| | |
|---------------|-----------|
| Verbinder | 7-14 / 44 |
| Verbundmörtel | 45 |
| Verpressen | 33-37 |

W

| | |
|-----------------------|------------|
| Wandanschlussrosetten | 21-25 / 45 |
|-----------------------|------------|

Z

| | |
|-----------------------------------|---------|
| Zentrierellipse zu DMC | 13 |
| Zentrumsschraube f. Spindeltreppe | 41 |
| Zuschneiden | 32 / 37 |
| Zweikomponentenmörtel | 45 |

Index A - Z

A

| | |
|-----------------------------|------------|
| Adjusting shim for distance | 22-25 / 46 |
| Adjustment gauge for DMC | 13 |
| Allen set screw | 44 |
| Anchor | 22-25 / 46 |
| Anti-slip tape | 42 / 48 |
| Assortment for staircases | 19-48 |

B

| | |
|-------------------------|-----------------|
| Balustrade tubes / bars | 34-37 / 47 / 48 |
| Bar Inox A2 | 30 / 47 |
| Bar jig (DMC) | 13 |
| Basic assortment | 7-14 |
| Bench screw | 7 / 12 |
| Bits for screw | 11 / 46 |
| Bolt | 19-21 / 46 / 47 |

C

| | |
|--------------------------------|--------------|
| CAD-planning | 17 |
| Cap | 10 / 44 |
| Cap nut | 38 / 39 / 47 |
| Center screw for spiral stairs | 42 |
| Chemical-mortar | 45 |
| Collar nut | 38 / 39 / 47 |
| Components for hanger | 30-37 |
| Connector with biscuit | 7-12 / 19-27 |
| Coupling | 35 / 44 |
| Cover sleeve | 46 |
| Cutter for grooving | 27 / 46 |
| Cutting | 32 / 37 |

D

| | |
|-------------------------|------------------------|
| Distance ring | 26 / 46 |
| Drill | 11 / 29 / 39 / 45 |
| Drill guide | 11 / 28 / 29 / 45 / 46 |
| Drill jig | 11 / 28 / 29 / 45 |
| Drill jig for dowel DMC | 13 |
| Drill jig for hanger | 39 / 48 |

E

| | |
|-----------------------------|--------------|
| Eccentric cam | 10 |
| Elements for steel stringer | 26 |
| End bearing | 30 / 34 / 47 |
| End stop | 34 / 44 |
| End stop for drill | 11 / 45 |
| Endscrew | 8 / 11 |
| Extension piece for drill | 39 / 45 |
| Extension piece for screw | 34 / 44 |

F

| | |
|-------------------------------|--------------|
| Face spanner for bearings | 39 / 47 |
| Fastener in steel stringer | 26 |
| Fixing element for furniture | 8 / 9 |
| Fixing element for mounting | 7-12 / 19-27 |
| Fixing elements | 7-12 / 44 |
| Fixing elements, euro screw | 8 |
| Fixing elements, metric screw | 8 / 12 / 44 |
| Fixing elements, wood screw | 7 / 8 / 12 |

G

| | |
|----------------------------|--------------|
| Guide bush for drill guide | 28 / 29 / 45 |
| Glass holder | 27 / 48 |

H

| | |
|---------------------|--------------|
| Hanger bolt | 39 / 44 |
| Hanger bolt driver | 39 / 44 |
| Hanger for steps | 30-39 |
| Height compensation | 33 / 34 / 47 |

I

| | |
|----------------------------|-------------------|
| Injection mortar | 45 |
| Inox bar | 30 / 48 |
| Inox tube | 34-37 / 47 |
| Internally threaded anchor | 11 / 33 / 44 / 45 |

L

| | |
|------------------|---------|
| List for cutting | 32 / 37 |
|------------------|---------|

M

| | |
|-----------------------|-----------------|
| Marking-tip | 11 |
| Mortar in cartridge | 45 |
| Mounting anchor | 22-25 / 43 / 45 |
| Mounting instructions | 28 / 31 / 35 |

N

| | |
|--------------|---------|
| Normes | 15 / 16 |
| Nylon socket | 11 |

O

| | |
|--------|--------------|
| O-ring | 33 / 34 / 47 |
|--------|--------------|

P

| | |
|-----------------------------|---------|
| Pile screwing for handrails | 38 / 48 |
| Pot to hammer in | 11 / 46 |
| Punty | 7-12 |

R

| | |
|--------------------|---------------|
| Reversible ratchet | 46 |
| Ring cover top | 30-34 / 47 |
| Rosettes | 21-34 / 45-48 |
| Round bar | 30 / 46 |

S

| | |
|------------------------------|-------------------|
| Screen tube | 22 / 25 / 45 |
| Screw | 11 / 40 / 43 / 44 |
| Screw for fastening at glass | 43 / 48 |
| Screw tool | 11 / 44 / 46 |
| Screwing ring | 28 / 45 |
| Screwing support for fixing | 28 / 45 |
| Set for staircases | 19 / 44 |
| Shelf support | 8 |
| Silencer bush | 33 / 34 / 47 |
| Silencer dowel | 23-25 / 45 |
| Silencer ring | 33 / 34 / 47 |
| Spiral stair center screw | 42 |
| Support bearing | 30-34 / 47 / 48 |
| Support for handrails | 43 / 48 |
| Suspension | 30-37 |

ST

| | |
|-------------------------|-------------------|
| Stamping | 33-39 / 44 |
| Stamping tool | 44 |
| Standards | 15 / 16 |
| Statics | 15 |
| Steel stringer fastener | 26 |
| Steel thread sleeve | 11 / 33 / 44 / 45 |

T

| | |
|------------------------------|-----------------|
| Tape anti-slip | 41 / 48 |
| Threadlocker | 47 |
| Thread sleeve | 11 / 30-33 / 44 |
| Threaded rods | 34-37 / 44 |
| Tool box for mounting | 14 / 42 |
| Tool box for staircases | 42 / 46 |
| Tool box to basic assortment | 14 |
| Tube Inox A2 | 34-37 / 47 |
| Tubes end stop | 33 / 34 / 44 |

U

| | |
|------------------------|--------------|
| Underlay for levelling | 33 / 34 / 47 |
|------------------------|--------------|

Bestellung Commande Order

Kunde, Client, Customer: _____

Kom., Commission: _____

Händler, Distributeur, Dealer: _____

www.lamifix.ch

lamifix@lamifix.ch

Tel: 0041 (0)55 225 48 48

Fax: 0041 (0)55 225 48 44



2016/17

Anwendungen Applications Applications

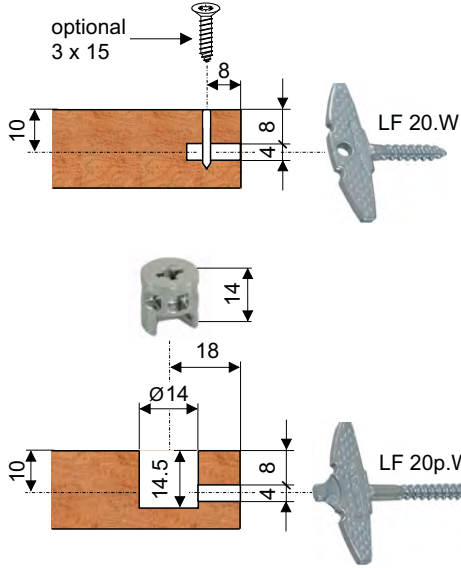

Fräsen Fraisage Grooving

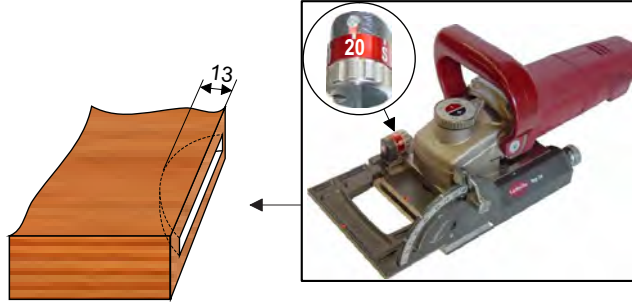

Eindreihen Visser Screwing



| Art. | | | Code | | CHF | Bestellung Commande Order |
|--------------|-------------|--------|------------|-----|--------|---------------------------------|
| LF 20s.W5x38 | 20 x 12 x 4 | 5 x 38 | 1020.001.1 | 50 | 84.50 | |
| | | | 1020.001.2 | 500 | 775.00 | |
| LF 20.W5x25 | 45 x 12 x 4 | 5 x 25 | 1020.003.1 | 50 | 81.50 | |
| | | | 1020.003.2 | 500 | 750.00 | |
| LF 20.W5x38 | 45 x 12 x 4 | 5 x 38 | 1020.004.1 | 50 | 84.00 | |
| | | | 1020.004.2 | 500 | 775.00 | |
| LF 20p.W5x38 | 45 x 18 x 4 | 5 x 38 | 1020.024.1 | 50 | 104.00 | |
| | | | 1020.024.2 | 500 | 955.00 | |

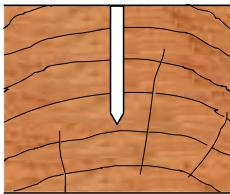

Holz, Bois, Wood

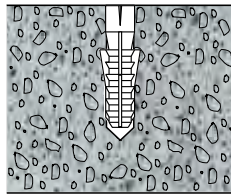

Beton, Béton, Concrete

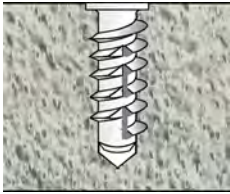

Porenbeton, Béton poreux
Gas concrete

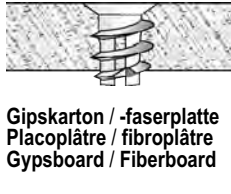

Gipskarton / -faserplatte
Placoplâtre / fibroplâtre
Gypsboard / Fiberboard

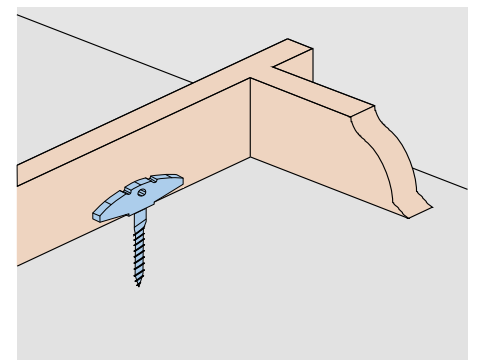
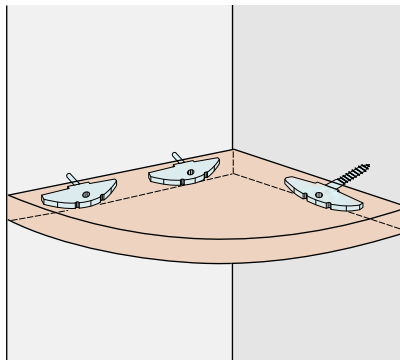
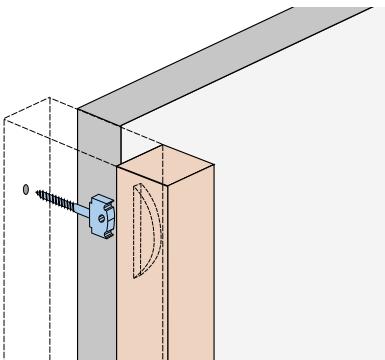

Bestellung Commande Order

Kunde, Client, Customer: _____

Kom., Commission: _____

Händler, Distributeur, Dealer: _____

www.lamifix.ch

lamifix@lamifix.ch

Tel: 0041 (0)55 225 48 48

Fax: 0041 (0)55 225 48 44



2016/17

Anwendungen Applications Applications

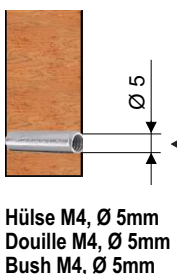
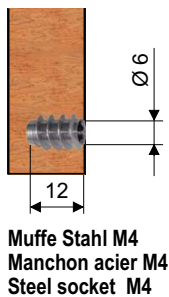
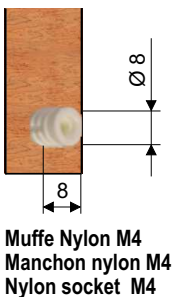
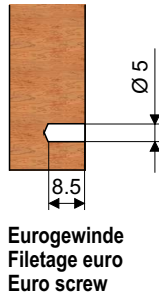
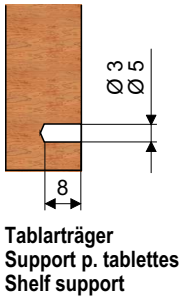
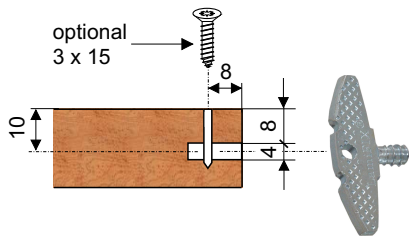
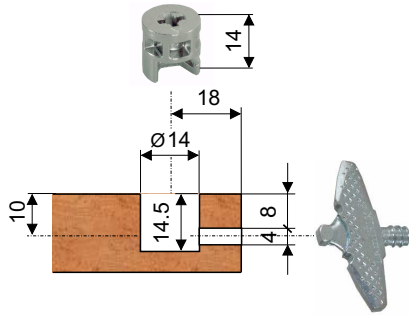

Fräsen Fraiseage Grooving

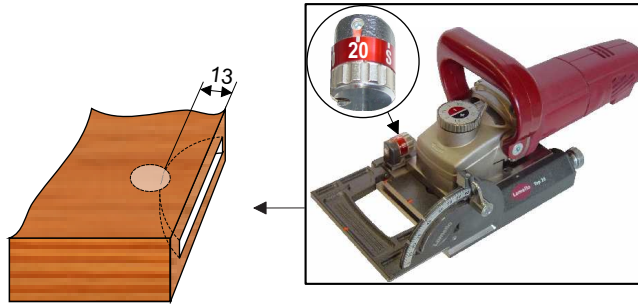

Eindrehen Visser Screwing



| Art. | | | Code | | CHF | Bestellung Commande Order |
|-----------------|--|-------------|-----------|------------|-----|---------------------------------|
| LF 20.E6.3x8.5 | | 45 x 12 x 4 | 6.3 x 8.5 | 1020.006.1 | 50 | 57.00 |
| | | | | 1020.006.2 | 500 | 490.00 |
| LF 20.M4x7.5 | | 45 x 12 x 4 | M4 x 7.5 | 1020.008.1 | 50 | 55.00 |
| | | | | 1020.008.2 | 500 | 470.00 |
| LF 20.T3x8 | | 45 x 12 x 4 | Ø 3 x 8 | 1020.010.1 | 50 | 54.50 |
| | | | | 1020.010.2 | 500 | 445.00 |
| LF 20.T5x8 | | 45 x 12 x 4 | Ø 5 x 8 | 1020.012.1 | 50 | 54.50 |
| | | | | 1020.012.2 | 500 | 445.00 |
| LF 20p.E6.3x8.5 | | 45 x 18 x 4 | 6.3 x 8.5 | 1020.026.1 | 50 | 68.00 |
| | | | | 1020.026.2 | 500 | 600.00 |
| LF 20p.M4x7.5 | | 45 x 18 x 4 | M4 x 7.5 | 1020.028.1 | 50 | 65.50 |
| | | | | 1020.028.2 | 500 | 575.00 |

Bestellung Commande Order

Kunde, Client, Customer: _____

Kom., Commission: _____

Händler, Distributeur, Dealer: _____

www.lamifix.ch

lamifix@lamifix.ch

Tel: 0041 (0)55 225 48 48

Fax: 0041 (0)55 225 48 44







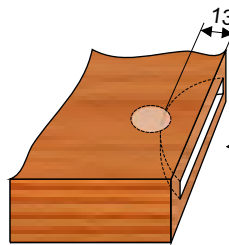
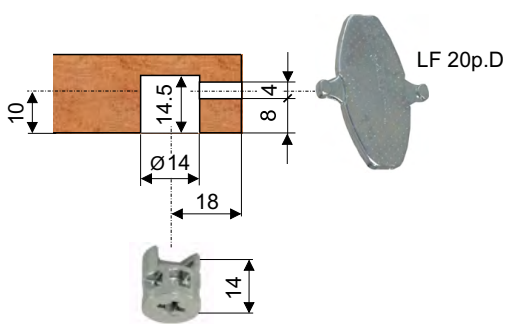

2016/17

**Anwendungen
Applications
Applications**



**Fräsen
Fraisage
Grooving**



| Art. |  | Code |  |  | Bestellung Commande Order |
|----------|---|------------|---|---|---|
| LF 20p.D | 50 x 36 x 4 | 1020.044.1 | 25 | 31.75 |  |
| | | 1020.044.2 | 500 | 555.00 |  |

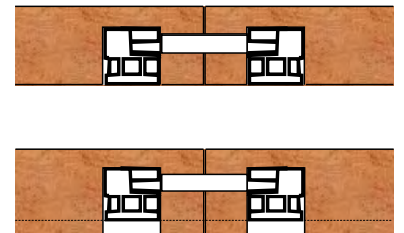
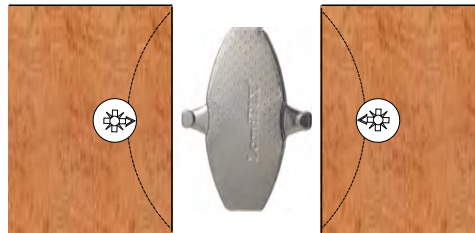
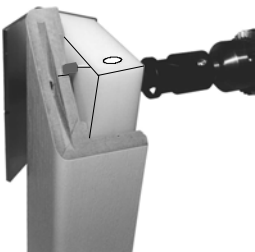

**Bohrschablone
Gabarit de perçage
Drill jig**

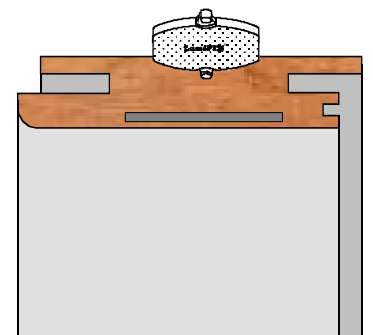
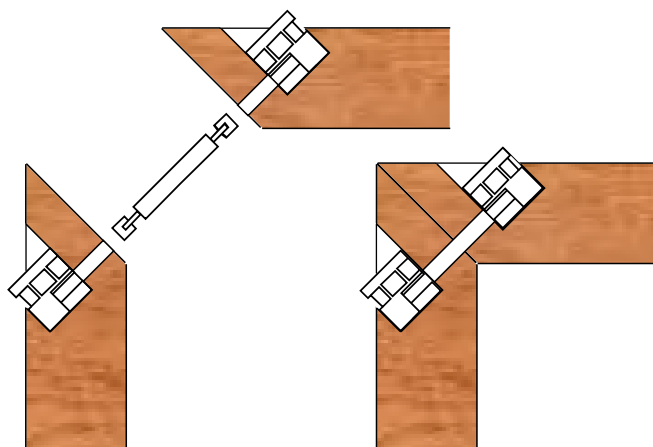

Bestellung Commande Order

Kunde, Client, Customer: _____

Kom., Commission: _____

Händler, Distributeur, Dealer: _____

www.lamifix.ch

lamifix@lamifix.ch

Tel: 0041 (0)55 225 48 48

Fax: 0041 (0)55 225 48 44



2016/17

Anwendungen Applications

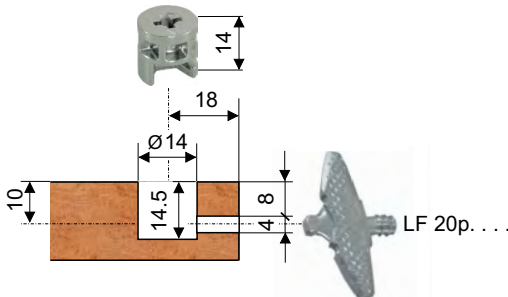

| Art. | | | Code | | | Bestellung Commande Order |
|-----------|--------------------------------------|-----------|------------|-------|--------|---------------------------------|
| LF 114p. | | Ø 14 | 1114.021.1 | 50 | 16.50 | |
| | | | 1114.021.2 | 500 | 150.00 | |
| | Ohne Rand, Sans bord, Without border | | | | | |
| LF 114p.C | | Ø 14 / 16 | 1114.022.1 | 50 | 18.50 | |
| | | | 1114.022.2 | 500 | 170.00 | |
| | Mit Rand, Avec bord, With border | | | | | |
| LF 414.01 | RAL 9010 | Ø 18 | 1414.001.1 | 100 | 6.60 | |
| | | | 1414.001.2 | 1'000 | 60.00 | |
| | Weiss, Blanc, White | | | | | |
| LF 414.02 | RAL 9011 | Ø 18 | 1414.002.1 | 100 | 6.60 | |
| | | | 1414.002.2 | 1'000 | 60.00 | |
| | Schwarz, Noir, Black | | | | | |
| LF 414.03 | RAL 1014 | Ø 18 | 1414.003.1 | 100 | 6.60 | |
| | | | 1414.003.2 | 1'000 | 60.00 | |
| | Kiefer, Pin, Pine | | | | | |
| LF 414.04 | RAL 1011 | Ø 18 | 1414.004.1 | 100 | 6.60 | |
| | | | 1414.004.2 | 1'000 | 60.00 | |
| | Buche, Hêtre, Beech | | | | | |
| LF 414.05 | RAL 8007 | Ø 18 | 1414.005.1 | 100 | 6.60 | |
| | | | 1414.005.2 | 1'000 | 60.00 | |
| | Braun, Marron, Brown | | | | | |
| LF 414.06 | RAL 8014 | Ø 18 | 1414.006.1 | 100 | 6.60 | |
| | | | 1414.006.2 | 1'000 | 60.00 | |
| | Dunkelbraun, Brun foncé, Dark brown | | | | | |
| LF 414.07 | RAL 8016 | Ø 18 | 1414.007.1 | 100 | 6.60 | |
| | | | 1414.007.2 | 1'000 | 60.00 | |
| | Mahagoni, Acajou, Mahogany | | | | | |
| LF 414.08 | RAL 7035 | Ø 18 | 1414.008.1 | 100 | 6.60 | |
| | | | 1414.008.2 | 1'000 | 60.00 | |
| | Grau, Gris, Grey | | | | | |

Bestellung Commande Order

Kunde, Client, Customer: _____

Kom., Commission: _____

Händler, Distributeur, Dealer: _____



www.lamifix.ch

lamifix@lamifix.ch

Tel: 0041 (0)55 225 48 48

Fax: 0041 (0)55 225 48 44

2016/17

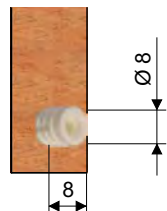

Muffe Nylon M4
Manchon nylon M4
Nylon socket M4

| Art. | Code | | | | Bestellung Commande Order |
|-----------|------------|-----------|-------|-------|---------------------------------|
| LF 420.M4 | 1440.001.1 | Ø 8.0 x 8 | 100 | 7.50 | |
| | 1440.001.2 | | 1'000 | 68.00 | |

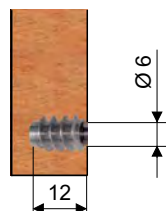

Muffe Stahl M4
Manchon acier M4
Steel socket M4

| | | | | | |
|-------------|------------|------------|-------|--------|--|
| LF 1441.001 | 1441.001.1 | Ø 6.0 x 12 | 100 | 33.00 | |
| | 1441.001.2 | | 1'000 | 298.00 | |

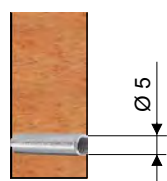

Hülse Stahl verzinkt, M4
Douille acier zingué, M4
Bush galvanized, M4

| | | | | | |
|-----------|------------|---------------|-------|--------|--|
| LF 440.15 | 1450.150.1 | Ø 5.0 x 15 mm | 100 | 10.20 | |
| | 1450.150.2 | | 1'000 | 95.20 | |
| LF 440.18 | 1450.180.1 | Ø 5.0 x 18 mm | 100 | 11.30 | |
| | 1450.180.2 | | 1'000 | 107.10 | |
| LF 440.22 | 1450.220.1 | Ø 5.0 x 22 mm | 100 | 12.55 | |
| | 1450.220.2 | | 1'000 | 119.00 | |
| LF 440.30 | 1450.300.1 | Ø 5.0 x 30 mm | 100 | 14.90 | |
| | 1450.300.2 | | 1'000 | 139.90 | |



Endschraube M4x8
Vis finale M4x8
Endscrew M4x8

| | | | | | |
|-----------|------------|---------------------|-------|-------|--|
| LF 441.Ni | 1460.001.1 | vernickelt, nickelé | 100 | 9.10 | |
| | 1460.001.2 | nickled | 1'000 | 85.50 | |
| LF 441.02 | 1460.002.1 | dunkel, foncé | 100 | 9.40 | |
| | 1460.002.2 | dark | 1'000 | 88.30 | |



inkl. Tiefenanschlag
incl. butée de profondeur
incl. depth collar

| | | | | | |
|--------------|------------|-----------|---|-------|--|
| LF 2031.025 | 2031.025.3 | Ø 2.5, HS | 1 | 5.70 | |
| LF 2041.050* | 2041.050.3 | Ø5.0, HW* | 1 | 43.00 | |
| LF 2041.080* | 2041.080.3 | Ø8.0, HW* | 1 | 47.00 | |



inkl. Tiefenanschlag
incl. butée de profondeur
incl. depth collar

| | | | | | |
|--------------|------------|------------|---|-------|--|
| LF 2031.140 | 2031.140.3 | Ø 14.0, HS | 1 | 48.00 | |
| LF 2041.140* | 2041.140.3 | Ø 14.0, HW | 1 | 73.50 | |

*HW In Bohrbüchsen ungeeignet / ne pas utiliser des canons de perçage / not for use in drill guides



Bohrbüchse
Canon de perçage
Drill guide

| | | | | | |
|-----------|------------|----------------|---|-------|--|
| LF 205.DG | 2110.050.3 | Ø5.0, gehärtet | 1 | 12.50 | |
| LF 206.DG | 2110.060.3 | Ø6.0, trempé | 1 | 12.50 | |
| LF 208.DG | 2110.080.3 | Ø8.0, hardened | 1 | 12.50 | |



Markierspitze
Pointe de marquage
Marking-tip

| | | | | | |
|-------------|------------|---------------------|---|-------|--|
| LF 220_MT-4 | 2131.020.4 | Set = 4 Stk. / pcs. | 1 | 24.00 | |
|-------------|------------|---------------------|---|-------|--|



Eindrehwerkzeug LamiFIX
Outil à visser LamiFIX
Screwing tool LamiFIX

| | | | | | |
|-------------|------------|-----------------|---|-------|--|
| LF 2150.020 | 2150.020.3 | → LF 20... | 1 | 37.00 | |
| LF 230.BIT | 2150.030.3 | → LF 30 + 35... | 1 | 37.00 | |

Bestellung Commande Order

Kunde, Client, Customer: _____

Kom., Commission: _____

Händler, Distributeur, Dealer: _____

www.lamifix.ch

lamifix@lamifix.ch

Tel: 0041 (0)55 225 48 48

Fax: 0041 (0)55 225 48 44



2016/17

Top 20

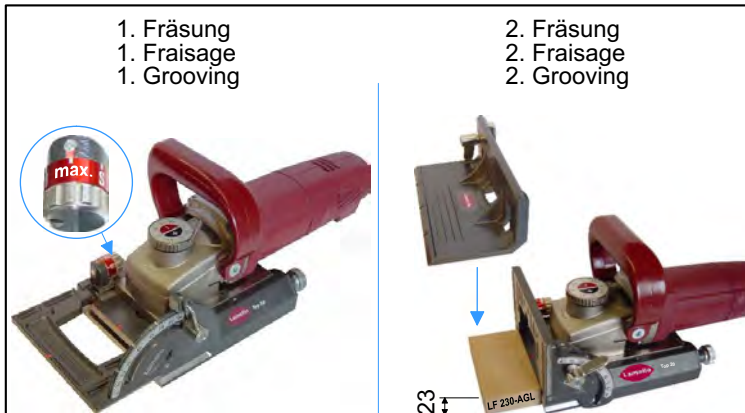

Optional: LF 30 = 12
LF 35 = 15

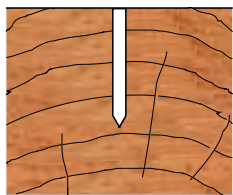
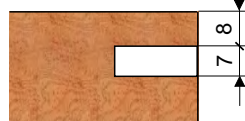
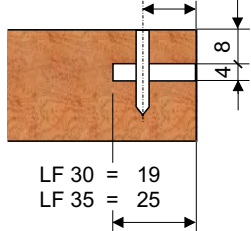

Holz, Bois, Wood

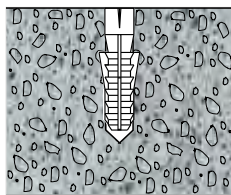

Beton, Béton, Concrete

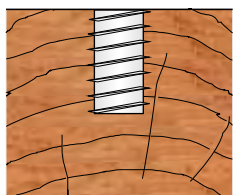

Holz, Bois, Wood

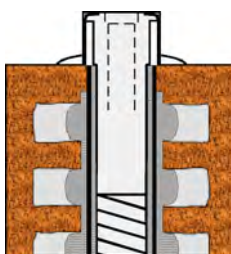

Ziegelstein, Brique, Brick

Zeta

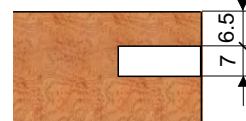
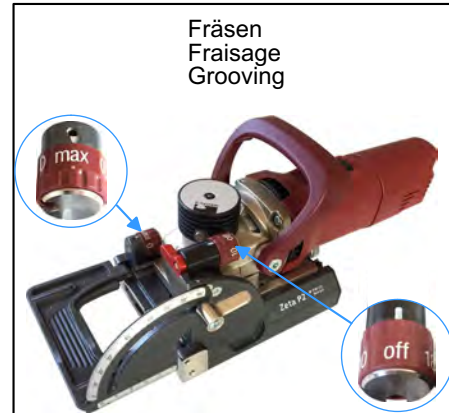

Eindreihen Visser Screwing



| Art. | | | Code | | | Bestellung Commande Order |
|---------------|-------------|----------|------------|-----|--------|---------------------------------|
| LF 30.W6.5x60 | 55 x 18 x 7 | 6.5 x 60 | 1030.001.1 | 25 | 64.75 | |
| | | | 1030.001.2 | 200 | 484.00 | |



| | | | | | | |
|---------------|-------------|----------|------------|-----|--------|--|
| LF 35.M 10x30 | 35 x 22 x 7 | M10 x 30 | 1035.130.1 | 25 | 97.00 | |
| | | | 1035.130.2 | 200 | 748.00 | |



| | | | | | |
|--------------------------|----------------|------------|---|--------|--|
| LF 2199.105.3 | Ø 105 / 30, HW | 2199.105.3 | 1 | 329.00 | |
| Fräser für Nute 7 x 25mm | | Optional | | | |
| Fraise à rainurer | | En option | | | |
| Cutter for grooving | | Optional | | | |

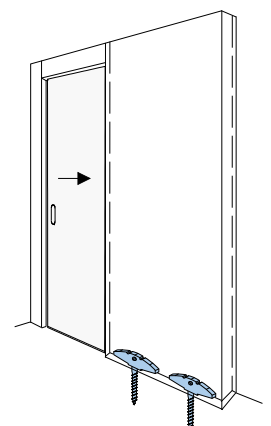
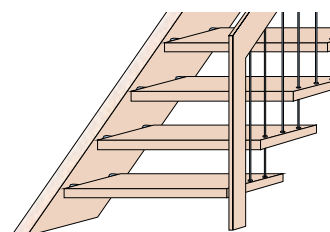
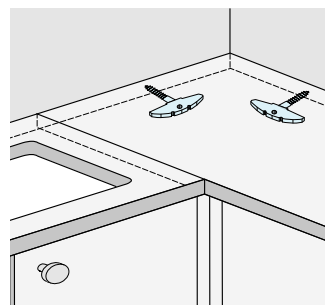
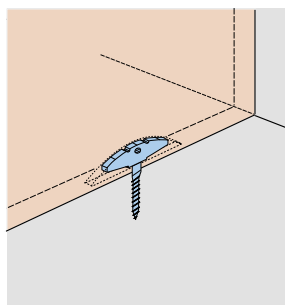

Bestellung Commande Order

Kunde, Client, Customer: _____

Kom., Commission: _____

Händler, Distributeur, Dealer: _____

www.lamifix.ch

lamifix@lamifix.ch

Tel: 0041 (0)55 225 48 48

Fax: 0041 (0)55 225 48 44



2016/17

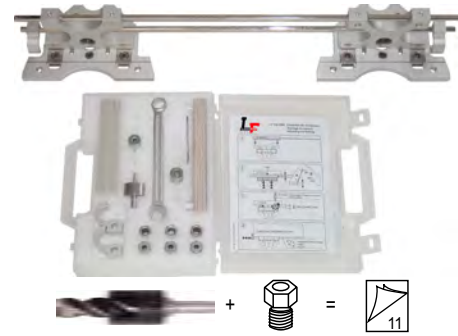

| Art. | Code | | | |
|--------------|------------|---|--------|--|
| LF 220.DMC-1 | 2220.001.5 | 1 Stk. pcs | 267.00 | |
| LF 220.DMC-2 | 2220.002.5 | Set = 2 Stk. pcs Inkl. Werkzeug, Outils incl., Incl. tools | 581.00 | |
| LF 220.DMC-3 | 2220.003.5 | Set = 3 Stk. pcs Inkl. Werkzeug, Outils incl., Incl. tools | 848.00 | |
| LF 220_ES-2 | 2140.001.4 | Endanschlag 2 Stk. pcs Butée finale, End stop | 22.00 | |

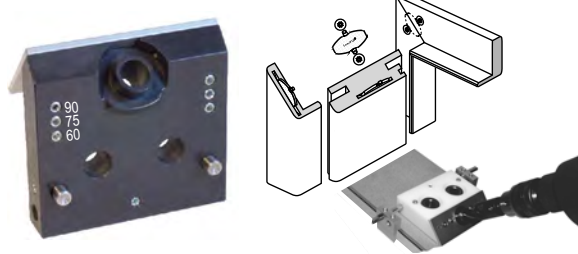
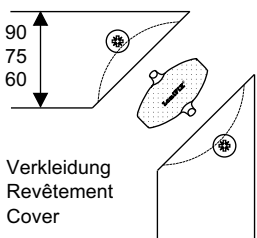
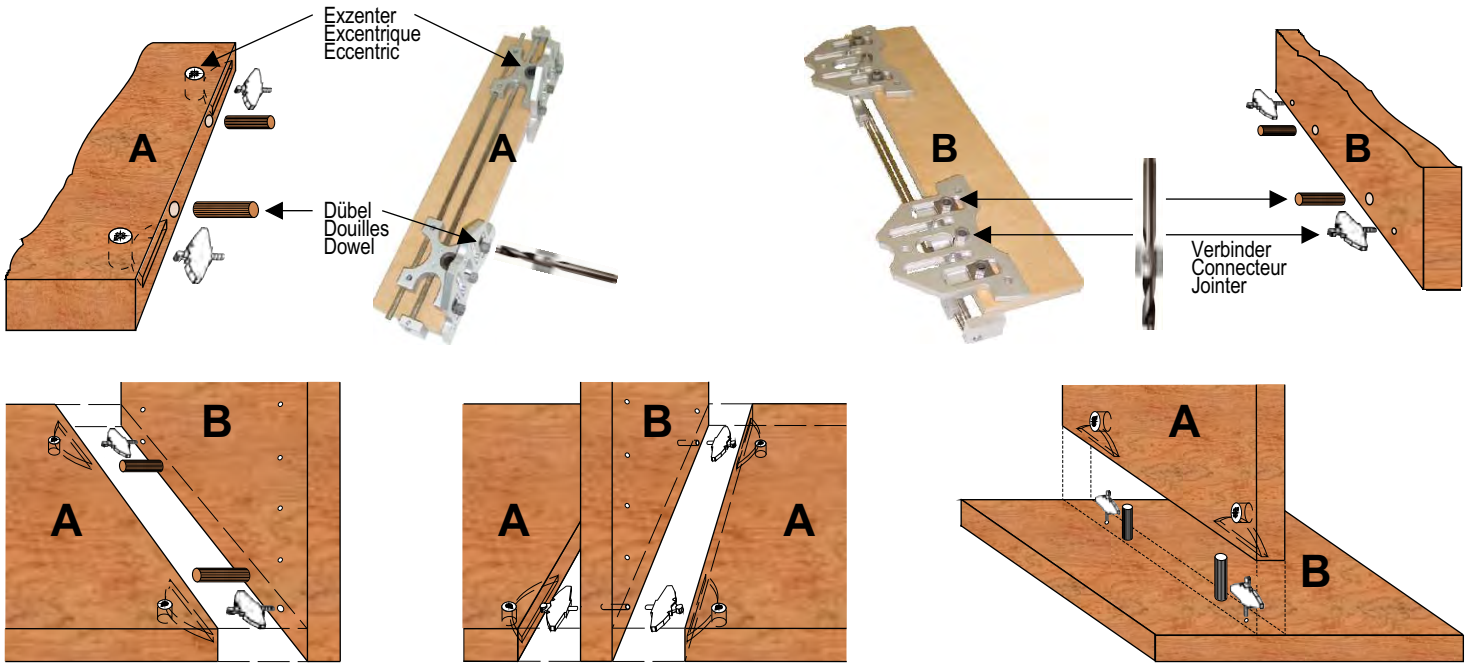

| Art. / Code | | | |
|---------------------------|------------|--------|--|
| LF 220.DMD 2220.020.3 | 1 Stk. pcs | 195.00 | |
| LF 220_ES-2 2140.001.4 | 2 Stk. pcs | 22.00 | |

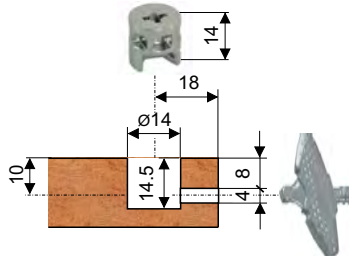
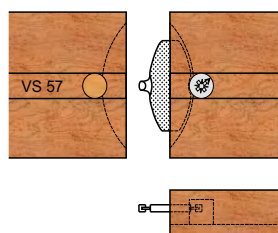

Im Montagekoffer enthalten
Inclus dans le coffret de montage
Included in tool box

| Art. / Code | | | |
|--------------------------|------------|-------|--|
| LF 220.DMU 2220.040.3 | 1 Stk. pcs | 52.80 | |

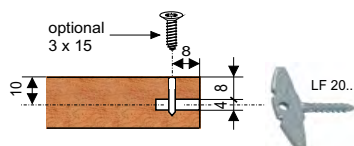

Bestellung Commande Order

Kunde, Client, Customer: _____

Kom., Commission: _____

Händler, Distributeur, Dealer: _____

www.lamifix.ch

lamifix@lamifix.ch

Tel: 0041 (0)55 225 48 48

Fax: 0041 (0)55 225 48 44



2016/17

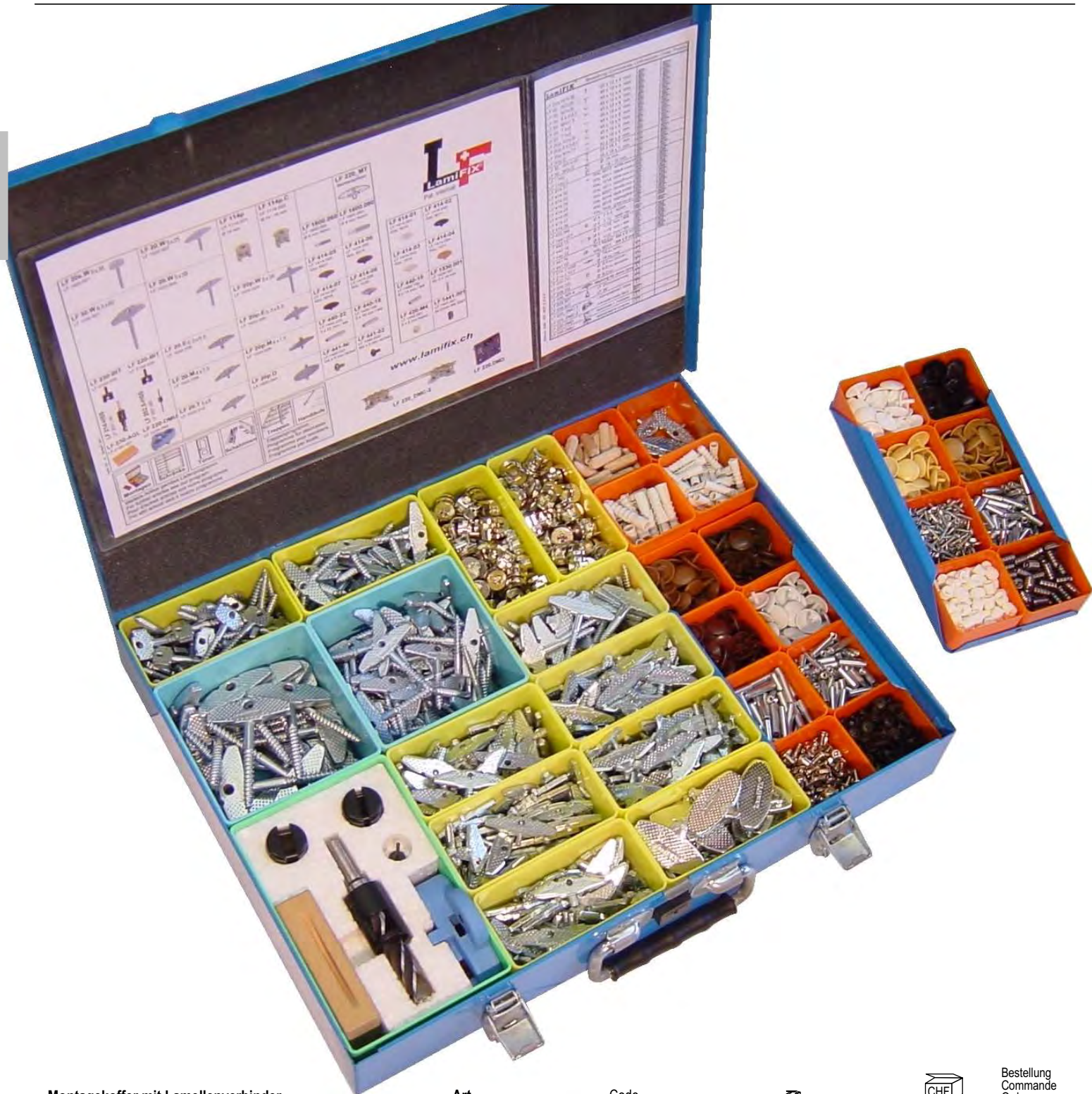

Montagekoffer mit Lamellenverbinder
Coffret de montage avec l'assortiment de base
Tool box with basic assortment

| Art. | Code | Stk. pcs | CHF | Bestellung Commande Order |
|--|------------|------------|--------|---------------------------------|
| LF 394.HIT | 3394.015.5 | 1 Stk. pcs | 549.00 | |
| Inkl. 200 Verbinder, 100 Exzenter, 7 Werkzeuge + 500 Zubehörteile Incl. 200 éléments d'assemblage, 100 excentriques, 7 outils + 500 accessoires Incl. 200 fixing elements, 100 eccentrics, 7 tools + 500 accessories | | | | |



LF 394.HIT



LF 220.DMC-2



LF 220.DMD

| | | | | |
|---|------------|-----|----------|--|
| LF 395.HIT | 3395.015.5 | Set | 1'290.00 | |
| Komplette Grundausrüstung (50.00 CHF Rabatt) Équipement de base complet (50.00 CHF réduction) Complete basic equipment (50.00 CHF discount) | | | | |

Wir danken der Hochschule für Technik in Rapperswil für ihre Zusammenarbeit, besonders Herrn Prof. Felix Wenk, dipl. Bauingenieur ETH / SIA / WTA / GfKORR, für statische Berechnungen und Normenteil, sowie Herrn Martin Egli, Fachstelle Baustoffprüfung, für die neuen Labortests.

Nous remercions l'Ecole Polytechnique de Rapperswil pour sa coopération, notamment M. Prof. Felix Wenk, ingénieur diplômé ETH / SIA / WTA / GfKORR pour les calculs de statique et pour la part des normes ainsi que M. Martin Egli, directeur de bureau de construction des matériaux d'essai pour les nouveaux tests en laboratoire.

We would like to thank the Institute of Technology in Rapperswil for its cooperation, especially Mr. Prof. Felix Wenk, graduated engineer ETH / SIA / WTA / GfKORR for the static calculations and for the standards part, as well as Mr. Martin Egli, director of construction materials testing for the new laboratory tests.

Grundlagen: EN 1995-1-1 : 2010-12 (Eurocode 5-1-1)
 Base: SIA 263 : 2013
 Basic: SIA 265 : 2012

Holzsortierungen / Qualität: EN 338
 Triage des bois / qualité: EN 1194
 Wood gradings / quality: SIA 265

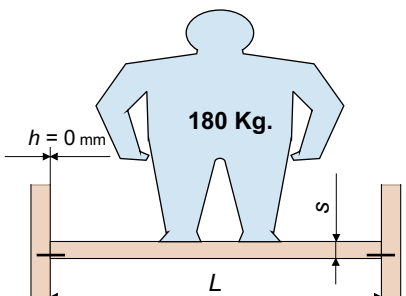
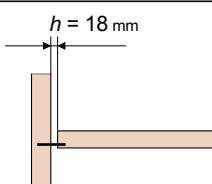
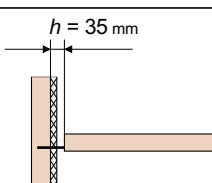
| | L | s |
|---|--|--|
|  | Stufenlänge Longueur des marches Step length | Hartholz D30 Bois dur D30 Hardwood D30 EN 338 |
| | mm | mm |
| | 900 | 36* - 40 |
| | 1000 | 40* - 44 |
| | 1100 | 40* - 44 |
|  | 900 | 36* - 40 |
| | 1000 | 40* - 44 |
| | 1100 | 40* - 44 |
| | 1200 | 42* - 46 |
|  | 900 | 36* - 40 |
| | 1000 | 40* - 44 |
| | 1100 | 40* - 44 |
| | 1200 | 42* - 46 |

* Statisch erforderlich.
 Données statiques indispensables.
 Static requirement.

DE Innentreppen

| | |
|----------------------------|---|
| Podesttreppen: | In der Regel für alle Bauten geeignet. |
| Gerade Treppen: | Bei Mehrfamilienhäuser, Zwischenpodest vorsehen. |
| Gewendelte Treppen: | Mehrheitlich in Einfamilienhäuser. |
| Spindeltreppen: | Als Haupttreppen vermeiden. |
| Steiltreppen: | Auftritt wechselseitig, bedingt zulässig. Durchgang $\geq 500 - 700\text{mm}$, beidseitig Handläufe. |

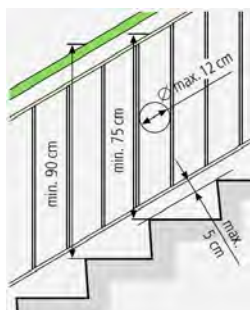

| | |
|-------------------|--|
| Sicherungen: | Öffnungen $\leq \varnothing 120\text{mm}$. |
| Zwischenpodeste: | Mindestens nach 18 Stufen. |
| Steigverhältnis: | $2 \times \downarrow + 1 \times \leftrightarrow = \sim 620 - 640\text{mm}$ (Gehlinienbereich). |
| Gehlinie: | Von der Innenseite, Spindeltreppen von der Aussenseite. |
| Auftritt: | Bei der Gehlinie $\sim 250 - 290\text{mm}$, beim Treppenauge $\sim 120\text{mm}$. |
| Durchgangsbreite: | In Einfamilienhäuser $\geq 900\text{mm}$, im Mehrfamilienhäuser $\geq 1200\text{mm}$. |
| Wandabstand: | Stufen und Podeste $\leq 50\text{mm}$, Handläufe $\geq 50\text{mm}$. |
| Absturzsicherung: | Geländer und Brüstungen $\geq 1000\text{mm}$. Im Treppenlauf $\geq 900\text{mm}$. |
| Wand-Handläufe: | Stufen Vorderkante - Handlauf Oberkante $\downarrow 850 - 900\text{mm}$. $\varnothing 40 - 50\text{mm}$. |

FR Escaliers intérieurs

| | |
|-------------------------------|---|
| Escaliers avec palier: | Convient pour tous les bâtiments. |
| Escaliers droits: | Pour immeubles publiques; prévoir des paliers. |
| Escaliers tournants: | Convenant pour les maisons individuelles. |
| Escaliers à colimaçon: | Déconseillé pour escaliers principaux. |
| Escaliers de meunier: | Marche alternante, admission limitée, passage $\geq 500 - 700\text{mm}$, mains courantes des deux côtés. |
| Garde corps: | Ouverture $\leq \varnothing 120\text{mm}$. |
| Palier: | Au moins après 18 marches. |
| Rapport inclinaison: | $2 \times \downarrow + 1 \times \leftrightarrow = \sim 620 - 640\text{mm}$ (ligne de foulée). |
| Ligne de foulée: | Du côté intérieur; escaliers tournants du côté extérieur. |
| Giron: | Sur la ligne de foulée $\sim 250 - 290\text{mm}$. Près de la lunette $\sim 120\text{mm}$. |
| Emmarchement: | Dans les maisons individuelles $\geq 900\text{mm}$. Dans les immeubles publiques $\geq 1200\text{mm}$. |
| Distance du mur: | Marches et estrades $\leq 50\text{mm}$, mains courantes $\geq 50\text{mm}$. |
| Hauteur de balustrade: | Pour escaliers et garde corps $\geq 1000\text{mm}$. La volée d'escalier $\geq 900\text{mm}$. |
| Mains courantes: | Nez de marche - bord supérieur main courante $\downarrow 850 - 900\text{mm}$. $\varnothing 40 - 50\text{mm}$. |

EN Indoor stairs

| | |
|--------------------------|--|
| Pedestals stairs: | In general, suitable for all buildings. |
| Straight stairs: | By apartment buildings; consider half-pace. |
| Helical stairs: | Mostly in one-family houses. |
| Spiral stairs: | Unapt for main stairs. |
| Steep stairs: | Alternately step, limited admission, alley $\geq 500 - 700\text{mm}$, handrails on both sides. |
| Safety: | Opening $\leq \varnothing 120\text{mm}$. |
| Half-pace: | After 18 steps at least. |
| Raising proportion: | $2 \times \downarrow + 1 \times \leftrightarrow = \sim 620 - 640\text{mm}$ (walk line area). |
| Walk line: | From the interior; spiral stairs from the exterior. |
| Step depth: | At the walk line $\sim 250 - 290\text{mm}$. At the inner well side string $\sim 120\text{mm}$. |
| Passage width: | In one-family houses $\geq 900\text{mm}$, in apartment buildings $\geq 1200\text{mm}$. |
| Wall distance: | Steps and half-paces $\leq 50\text{mm}$, handrails $\geq 50\text{mm}$. |
| Balustrade height: | For stairs and balustrades $\geq 1000\text{mm}$. At the stairway $\geq 900\text{mm}$. |
| Handrails: | Step leading edge - handrail upper edge $\downarrow 850 - 900\text{mm}$. $\varnothing 40 - 50\text{mm}$. |

Bestellung Commande Order

Kunde, Client, Customer: _____
 Kom., Commission: _____
 Händler, Distributeur, Dealer: _____
 CAD + Plots, CAO + plans: _____



2016/17

CAD-Planung, Plot Planification CAO, plans CAD-engineering, plots



- | | |
|----------------------------------|---|
| 1) Entwurf A4: | Grundriss + Seitenansicht (Perspektive) |
| 2) Plot 1:1 oder DXF mit Detail: | Wangen, Stufen + Handlauf |
| 3) Stücklisten für: | Holz + Beschläge |
| 1) Projet A4: | Plan horizontal + vue de côté |
| 2) Plot 1:1 ou DXF en détail: | Limons, marches + mains courantes |
| 3) Liste des pièces pour: | Bois + ferrures |
| 1) Layout A4: | Ground plan + side view |
| 2) Plot 1:1 or DXF with details: | Stringboards, steps + handrails |
| 3) Part lists for: | Wood + fittings |

CHF~

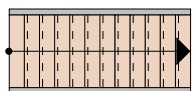

Gerade Treppe Escalier droit Straight stair

- | | | |
|--|--------|--|
| 1) Entwurf, Projet, Layout | 100.00 | |
| 2) Plot / DXF | 200.00 | |
| 3) Stücklisten, Liste des pièces, Part lists | 70.00 | |

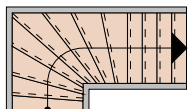

Treppe 1/4 gewunden Escalier 1/4 tournant Stair 1/4 helical

- | | | |
|--|--------|--|
| 1) Entwurf, Projet, Layout | 180.00 | |
| 2) Plot / DXF | 200.00 | |
| 3) Stücklisten, Liste des pièces, Part lists | 70.00 | |

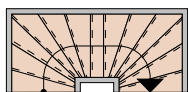

Treppe 2 x 1/4 gewunden Escalier 2 x 1/4 tournant Stair 2 x 1/4 helical

- | | | |
|--|--------|--|
| 1) Entwurf, Projet, Layout | 250.00 | |
| 2) Plot / DXF | 200.00 | |
| 3) Stücklisten, Liste des pièces, Part lists | 70.00 | |

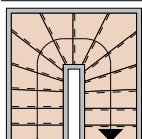

Treppe 1/2 gewunden Escalier 1/2 tournant Stair 1/2 helical

- | | | |
|--|--------|--|
| 1) Entwurf, Projet, Layout | 230.00 | |
| 2) Plot / DXF | 200.00 | |
| 3) Stücklisten, Liste des pièces, Part lists | 70.00 | |

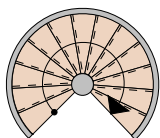

Spindeltreppe Escalier à colimaçon Spiral stair

- | | | |
|--|--------|--|
| 1) Entwurf, Projet, Layout | 250.00 | |
| 2) Plot / DXF | 200.00 | |
| 3) Stücklisten, Liste des pièces, Part lists | 70.00 | |

Spezialtreppe Escalier spécial Special stair

- | | | | |
|--------------|-----|--------|--|
| nach Aufwand | p/h | 135.00 | |
| selon frais | p/h | 135.00 | |
| at cost | p/h | 135.00 | |

Direkt bei: Directement chez: Directly by:

| | | | | |
|----------------------|-------|----------------------|----|--|
| Kälin AG | Tel | 0041 (0)56 622 00 07 | 1) | |
| Bremgartenstr. 10 | Mob | 0041 (0)79 312 92 88 | 2) | |
| CH-5622 Waltenschwil | Email | ruedikalin@gmail.com | 3) | |

Trüssel Datentechnik AG

| | | | | |
|-------------------|-------|----------------------|----|--|
| Sonnmatte 6 | Tel | 0041 (0)41 921 30 50 | 1) | |
| CH-6214 Schenk LU | Email | info@truessel.org | 2) | |
| | | | 3) | |



Mauron Fils SA

| | | | | |
|--------------------------|-------|--------------------------|----|--|
| Rte de Corserey 22 | Tel | 0041 (0)26 470 12 15 | 1) | |
| CH-1746 Prez-vers-Noréaz | Fax | 0041 (0)26 470 11 46 | 2) | |
| | Email | info@escaliers-mauron.ch | 3) | |



Markus Copei

| | | | | |
|------------------------------|-------|-------------------------|----|--|
| Karlstrasse 4a | Tel | 0049 (0)2951 933 565 | 1) | |
| DE-33142 Büren-Siddinghausen | Fax | 0049 (0)2951 933 567 | 2) | |
| | Email | treppenform@t-online.de | 3) | |



| | | |
|---------------------|------|-----------|
| Lieferfrist: | ca. | 1 Woche |
| Délai de livraison: | env. | 1 semaine |
| Term of delivery: | ca. | 1 week |

3

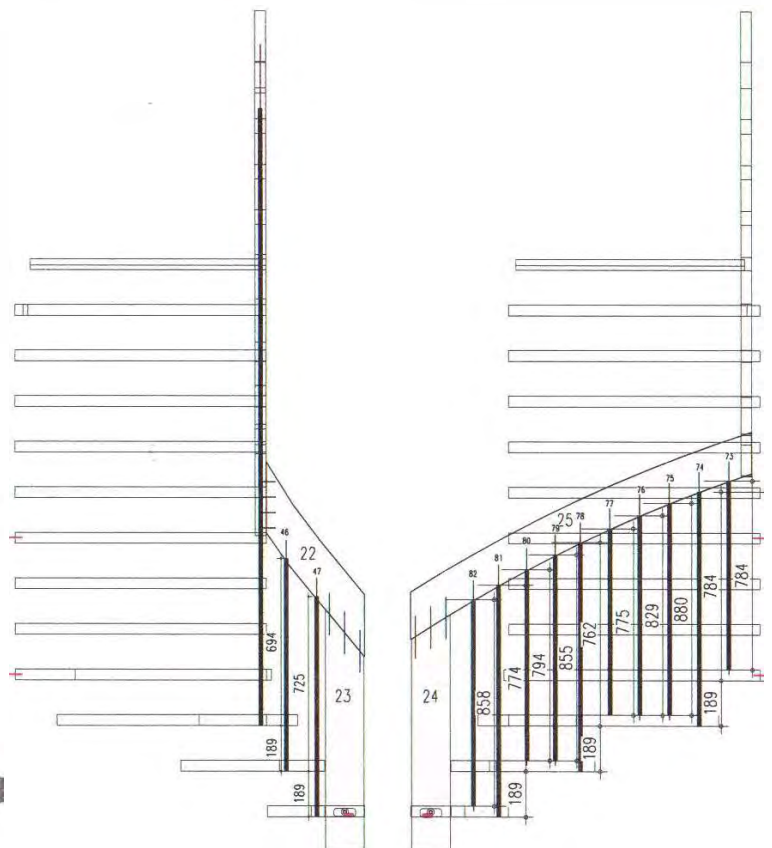
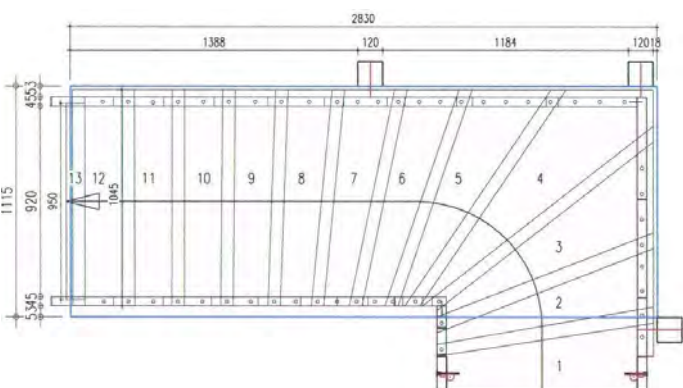
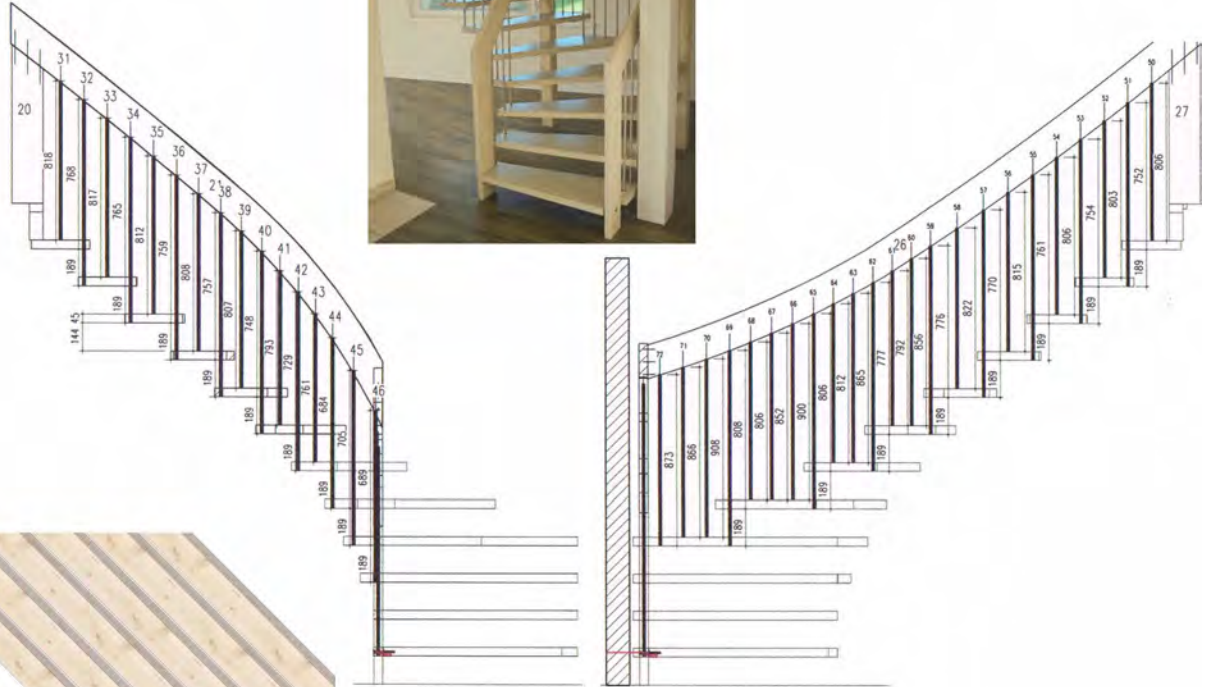

Bestellung Commande Order

Kunde, Client, Customer: _____

Kom., Commission: _____

Händler, Distributeur, Dealer: _____



www.lamifix.ch

lamifix@lamifix.ch

Tel: 0041 (0)55 225 48 48

Fax: 0041 (0)55 225 48 44

2016/17

| Holzrichtung-Faserverlauf Sens des fibres du bois Wood direction-fiber flow | T | | |
|---|----|----|----|
| | mm | mm | mm |
| Hartholz Bois dur Hardwood D30, EN 338 | 35 | 35 | 35 |
| Brettschichtholz Bois lamellé-collé Glued laminated wood GL24h GL28k EN 1194 | 50 | 50 | 65 |
| Weichholz Bois tendre Softwood C24, EN 338 | 50 | 65 | 80 |

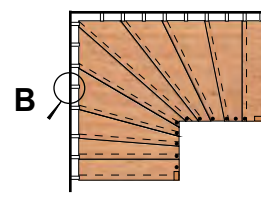
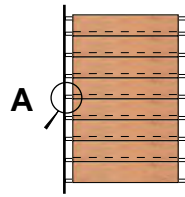
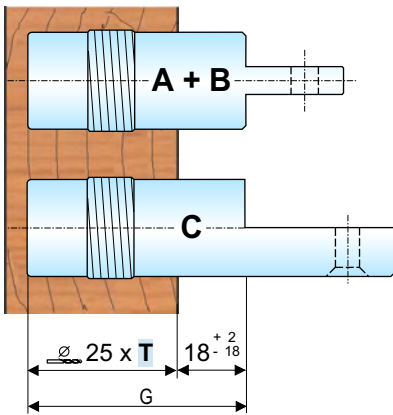

C = Schnellste Montage
Assemblage rapide
Fastest assembly

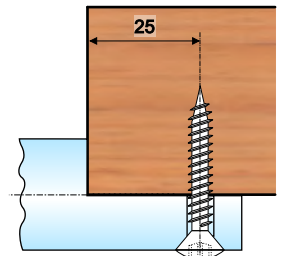
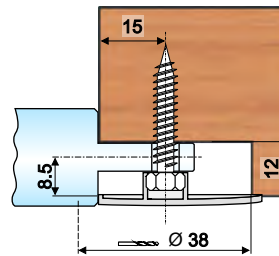
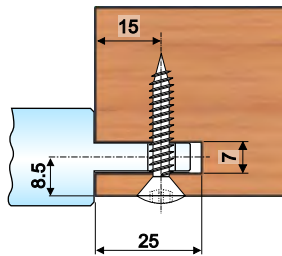
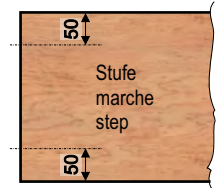
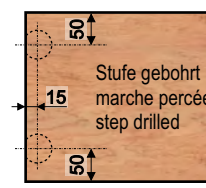
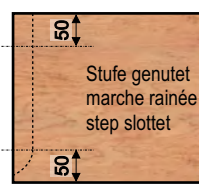

Art. / Code CHF

Art. / Code CHF

Art. / Code CHF

Set 1

Abdeckkappe, Capuchon, Cap
Schraube, Vis, Screw
Bolzen, Boulon, Bolt
Waxilit, Lubrifiant, Lube

A
LF 1541.002 0.38 1*
LF 3623.0 . . 9.95 - 12.75 1
LF 3625.001 0.09 1/50*

B
LF 1435.001 1.55 1
LF 1560.003 0.28 1*
LF 3623.0 . . 9.95 - 12.75 1
LF 3625.001 0.09 1/50*

C
LF 1541.003 0.39 1*
LF 3623.5 . . 9.95 - 12.75 1
LF 3625.001 0.09 1/50*

| T | G | Set | Art. / Code | CHF | Art. / Code | CHF | Art. / Code | CHF |
|-----------------|----------|----------|----------------|-------|----------------|-------|----------------|-------|
| T = 35mm | G = 53mm | 1 Set | LF 3623.135.4~ | 10.45 | LF 3623.235.4~ | 11.90 | LF 3623.535.4~ | 10.45 |
| | | ≥100 Set | LF 3623.135.6 | 9.92 | LF 3623.235.6 | 11.27 | LF 3623.535.6 | 9.93 |
| T = 50mm | G = 68mm | 1 Set | LF 3623.150.4~ | 11.05 | LF 3623.250.4~ | 12.50 | LF 3623.550.4~ | 11.05 |
| | | ≥100 Set | LF 3623.150.6 | 10.47 | LF 3623.250.6 | 11.82 | LF 3623.550.6 | 10.48 |
| T = 65mm | G = 83mm | 1 Set | LF 3623.165.4~ | 12.15 | LF 3623.265.4~ | 13.60 | LF 3623.565.4~ | 12.15 |
| | | ≥100 Set | LF 3623.165.6 | 11.52 | LF 3623.265.6 | 12.87 | LF 3623.565.6 | 11.53 |
| T = 80mm | G = 98mm | 1 Set | LF 3623.180.4~ | 13.25 | LF 3623.280.4~ | 14.70 | LF 3623.580.4~ | 13.25 |
| | | ≥100 Set | LF 3623.180.6 | 12.57 | LF 3623.280.6 | 13.92 | LF 3623.580.6 | 12.58 |

| Art. / Code | Détail | * | CHF |
|---------------|-----------|-----|-------|
| LF 1541.002.1 | A | 100 | 38.00 |
| LF 1541.003.1 | C | 100 | 39.00 |
| LF 1560.003.1 | B | 100 | 28.00 |
| LF 3625.001.1 | A / B / C | 1 | 4.70 |



| | | | | | | |
|---|---------------|--|-----------|---------------|--|-------|
| Eindrehwerkzeug, Outil à visser, Screw tool | LF 2150.036.3 | | 37.00 | LF 2151.036.3 | | 37.00 |
| Holzspiralbohrer, Mèche pour bois, Drill for wood | LF 2001.250.3 | | Ø 25mm HS | | | 95.00 |

Weitere Werkzeuge, plus d'outils, more tools

Bestellung Commande Order

Kunde, Client, Customer: _____

Kom., Commission: _____

Händler, Distributeur, Dealer: _____



www.lamifix.ch

lamifix@lamifix.ch

Tel: 0041 (0)55 225 48 48

Fax: 0041 (0)55 225 48 44

2016/17

| Holzrichtung-Faserverlauf Sens des fibres du bois Wood direction-fiber flow | T | | |
|---|----|----|----|
| | mm | mm | mm |
| Hartholz Bois dur Hardwood D30, EN 338 | 30 | 30 | 30 |
| Brettschichtholz Bois lamellé-collé Glued laminated wood EN 1194 | 38 | 38 | 53 |
| Weichholz Bois tendre Softwood C24, EN 338 | 38 | 53 | 68 |

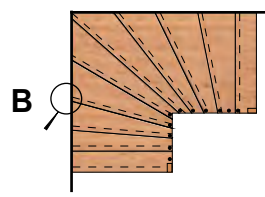
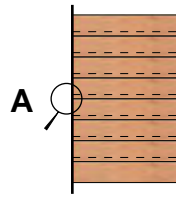
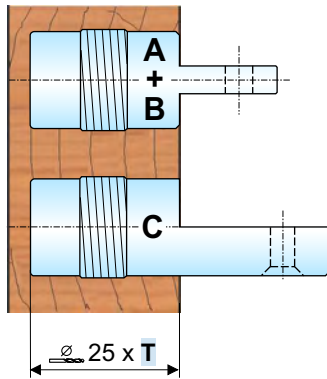

C = Schnellste Montage
Assemblage rapide
Fastest assembly

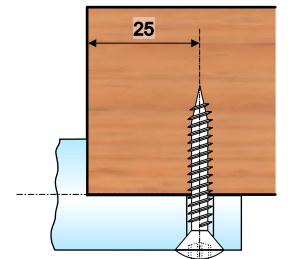
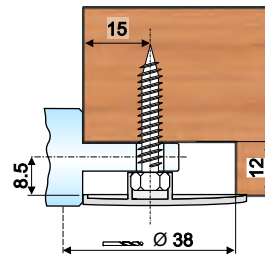
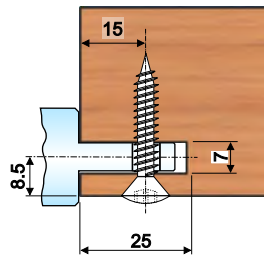
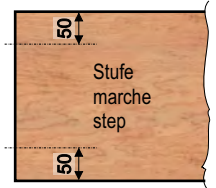
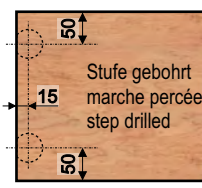
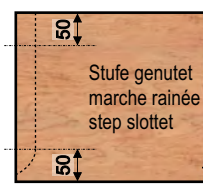

Art. / Code CHF Art. / Code CHF Art. / Code CHF

Set 3624

Abdeckkappe, Capuchon, Cap
Schraube, Vis, Screw
Bolzen, Boulon, Bolt
Waxilit, Lubrifiant, Lube

| | A | | | B | | | C | | |
|---------------|--------------|-------|--|---------------|--------------|-------|---------------|--------------|-------|
| LF 1541.002 | 0.38 | 1* | | LF 1435.001 | 1.55 | 1 | LF 1541.003 | 0.39 | 1* |
| LF 3624.0 . . | 9.35 - 10.55 | 1 | | LF 1560.003 | 0.28 | 1* | LF 3624.5 . . | 9.35 - 10.55 | 1 |
| LF 3625.001 | 0.09 | 1/50* | | LF 3624.0 . . | 9.35 - 10.55 | 1 | LF 3624.5 . . | 9.35 - 10.55 | 1 |
| | | | | LF 3625.001 | 0.09 | 1/50* | LF 3625.001 | 0.09 | 1/50* |

| T | Set | Art. / Code | CHF | Art. / Code | CHF | Art. / Code | CHF |
|------|----------|----------------|-------|----------------|-------|----------------|-------|
| 30mm | 1 Set | LF 3624.130.4~ | 9.85 | LF 3624.230.4~ | 11.30 | LF 3624.530.4~ | 9.85 |
| | ≥100 Set | LF 3624.130.6 | 9.35 | LF 3624.230.6 | 10.70 | LF 3624.530.6 | 9.36 |
| 38mm | 1 Set | LF 3624.138.4~ | 9.90 | LF 3624.238.4~ | 11.35 | LF 3624.538.4~ | 9.90 |
| | ≥100 Set | LF 3624.138.6 | 9.40 | LF 3624.238.6 | 10.75 | LF 3624.538.6 | 9.41 |
| 53mm | 1 Set | LF 3623.135.4~ | 10.45 | LF 3623.235.4~ | 11.90 | LF 3623.535.4~ | 10.45 |
| | ≥100 Set | LF 3623.135.6 | 9.92 | LF 3623.235.6 | 11.27 | LF 3623.535.6 | 9.93 |
| 68mm | 1 Set | LF 3623.150.4~ | 11.05 | LF 3623.250.4~ | 12.50 | LF 3623.550.4~ | 11.05 |
| | ≥100 Set | LF 3623.150.6 | 10.47 | LF 3623.250.6 | 11.82 | LF 3623.550.6 | 10.48 |



| Art. / Code | Détail | | CHF |
|---------------|-----------|-----|-------|
| LF 1541.002.1 | A | 100 | 38.00 |
| LF 1541.003.1 | C | 100 | 39.00 |
| LF 1560.003.1 | B | 100 | 28.00 |
| LF 3625.001.1 | A / B / C | 1 | 4.70 |

| | | | | | | |
|---|---------------|--|-----------|---------------|--|-------|
| Eindrehwerkzeug, Outil à visser, Screw tool | LF 2150.036.3 | | 37.00 | LF 2151.036.3 | | 37.00 |
| Holzspiralbohrer, Mèche pour bois, Drill for wood | LF 2001.250.3 | | Ø 25mm HS | | | 95.00 |

20 Weitere Werkzeuge, plus d'outils, more tools

Bestellung Commande Order

Kunde, Client, Customer: _____

Kom., Commission: _____

Händler, Distributeur, Dealer: _____



www.lamifix.ch

lamifix@lamifix.ch

Tel: 0041 (0)55 225 48 48

Fax: 0041 (0)55 225 48 44

2016/17

| Holzrichtung-Faserverlauf Sens des fibres du bois Wood direction-fiber flow | | T | | |
|---|-------------|----|----|----|
| | | | | |
| Hartholz Bois dur Hardwood | D30, EN 338 | 50 | 50 | 50 |
| Weichholz Bois tendre Softwood | C24, EN 338 | 65 | 80 | 80 |
| Dreischichtplatte Bois à trois couches Three-layer wood board | | 65 | 65 | 65 |
| OSB - Platte OSB - panneau OSB - board | | 65 | 65 | 65 |

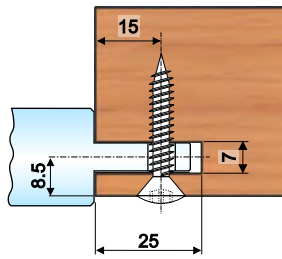
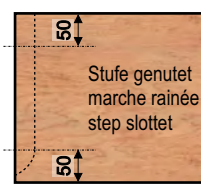
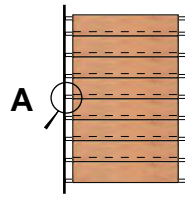
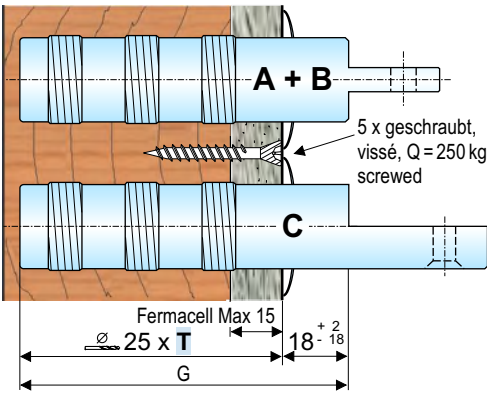

Art. / Code CHF

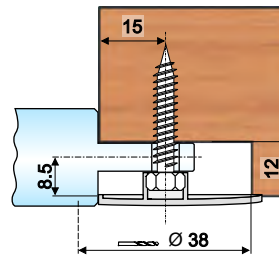
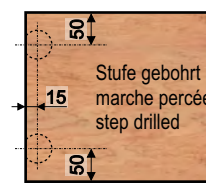
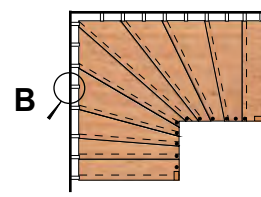

Art. / Code CHF

C = Schnellste Montage
Assemblage rapide
Fastest assembly

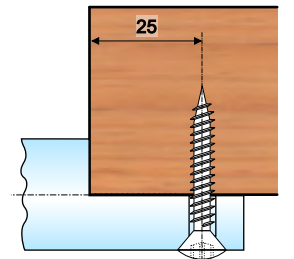
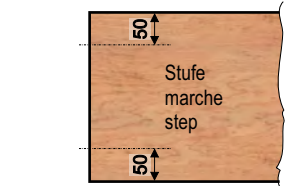

Art. / Code CHF

Set 2

| | A | | | B | | | C | | |
|----------------------------|---------------|---------------|-------|---------------|---------------|-------|---------------|---------------|-------|
| Abdeckkappe, Capuchon, Cap | LF 1435.001 | 1.55 | 1 | LF 1435.001 | 1.55 | 1 | LF 1435.001 | 1.55 | 1 |
| Schraube, Vis, Screw | LF 1530.006 | 0.75 | 5* | LF 1530.006 | 0.75 | 5* | LF 1530.006 | 0.75 | 5* |
| Schraube, Vis, Screw | LF 1541.002 | 0.38 | 1* | LF 1560.003 | 0.28 | 1* | LF 1541.003 | 0.39 | 1* |
| Rosette, Rosace | LF 1801.025 | 1.55 | 1 | LF 1801.025 | 1.55 | 1 | LF 1801.025 | 1.55 | 1 |
| Bolzen, Boulon, Bolt | LF 3623.0 . . | 10.55 - 12.75 | 1 | LF 3623.0 . . | 10.55 - 12.75 | 1 | LF 3623.5 . . | 10.55 - 12.75 | 1 |
| Waxilit, Lubrifiant, Lube | LF 3625.001 | 0.09 | 1/50* | LF 3625.001 | 0.09 | 1/50* | LF 3625.001 | 0.09 | 1/50* |

| | | | | | | | |
|--------------------------|----------|-----------------------|-------|-----------------------|-------|-----------------------|-------|
| T = 50mm G = 68mm | 1 Set | LF 3623.350.4~ | 13.35 | LF 3623.450.4~ | 14.80 | LF 3623.650.4~ | 13.35 |
| | ≥100 Set | LF 3623.350.6 | 12.67 | LF 3623.450.6 | 14.02 | LF 3623.650.6 | 12.68 |

| | | | | | | | |
|--------------------------|----------|-----------------------|-------|-----------------------|-------|-----------------------|-------|
| T = 65mm G = 83mm | 1 Set | LF 3623.365.4~ | 14.45 | LF 3623.465.4~ | 15.90 | LF 3623.665.4~ | 14.45 |
| | ≥100 Set | LF 3623.365.6 | 13.72 | LF 3623.465.6 | 15.07 | LF 3623.665.6 | 13.73 |

| | | | | | | | |
|--------------------------|----------|-----------------------|-------|-----------------------|-------|-----------------------|-------|
| T = 80mm G = 98mm | 1 Set | LF 3623.380.4~ | 15.55 | LF 3623.480.4~ | 17.00 | LF 3623.680.4~ | 15.55 |
| | ≥100 Set | LF 3623.380.6 | 14.77 | LF 3623.480.6 | 16.12 | LF 3623.680.6 | 14.78 |

| Art. / Code | Détail | | CHF |
|---------------|-----------|-----|-------|
| LF 1530.006.1 | A / B / C | 100 | 15.00 |
| LF 1541.002.1 | A | 100 | 38.00 |
| LF 1541.003.1 | C | 100 | 39.00 |
| LF 1560.003.1 | B | 100 | 28.00 |
| LF 3625.001.1 | A / B / C | 1 | 4.70 |



| | | | | | | |
|---|----------------------|--|-----------|----------------------|--|-------|
| Eindrehwerkzeug, Outil à visser, Screw tool | LF 2150.036.3 | | 37.00 | LF 2151.036.3 | | 37.00 |
| Holzspiralbohrer, Mèche pour bois, Drill for wood | LF 2001.250.3 | | Ø 25mm HS | LF 2001.250.3 | | 95.00 |

Weitere Werkzeuge, plus d'outils, more tools

Bestellung Commande Order

Kunde, Client, Customer: _____

Kom., Commission: _____

Händler, Distributeur, Dealer: _____



www.lamifix.ch

lamifix@lamifix.ch

Tel: 0041 (0)55 225 48 48

Fax: 0041 (0)55 225 48 44

2016/17

Im Ziegelstein eingemörtelt
Dans la brique, avec mortier chimique
In brick, cemented

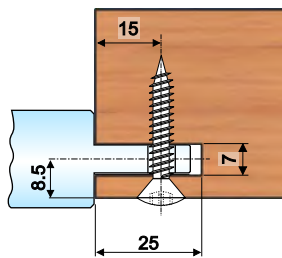
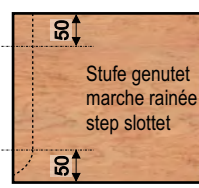
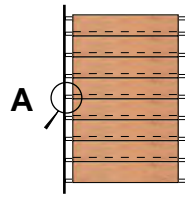
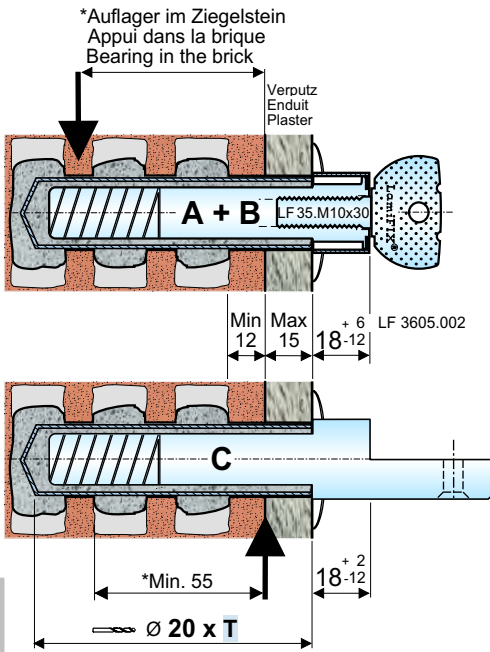

Art. / Code CHF

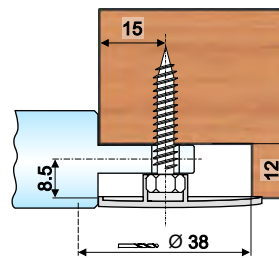
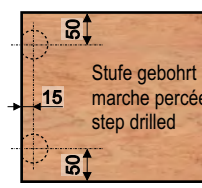
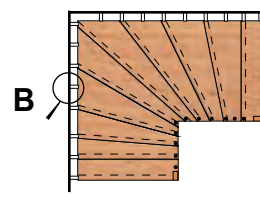

Art. / Code CHF

C = Schnellste Montage
Assemblage rapide
Fastest assembly

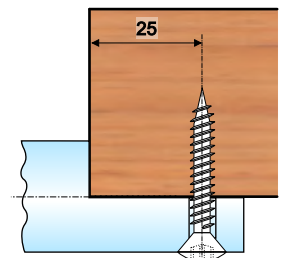
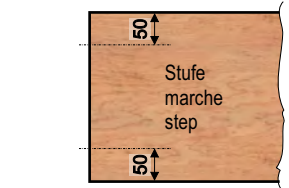

Art. / Code CHF

Set 5

| | LF 1035.130 | 3.88 | 1 | LF 1035.130 | 3.88 | 1 | | LF 1541.003 | 0.39 | 1* |
|---|-------------|------|--------|-------------|------|--------|--|-------------|-------|--------|
| Verbinder, Raccord, Fixing | LF 1035.130 | 3.88 | 1 | LF 1035.130 | 3.88 | 1 | | LF 1541.003 | 0.39 | 1* |
| Abdeckkappe Capuchon, Cap | LF 1541.002 | 0.38 | 1* | LF 1435.001 | 1.55 | 1 | | LF 1710.020 | 1.50 | 1 |
| Schraube, Vis, Screw | LF 1710.020 | 1.50 | 1 | LF 1560.003 | 0.28 | 1* | | LF 1720.002 | 3.94 | 1/9* |
| Siebhülse, Douille de passoire, Screen tube | LF 1720.002 | 3.94 | 1/9* | LF 1710.020 | 1.50 | 1 | | LF 1720.002 | 3.94 | 1/9* |
| Mörtel, Mortier chimique, Injection mortar (F120) | LF 1801.025 | 1.55 | 1 | LF 1720.002 | 3.94 | 1/9* | | LF 1801.025 | 1.55 | 1 |
| Rosette, Rosace | LF 1801.025 | 1.55 | 1 | LF 1801.025 | 1.55 | 1 | | LF 1801.025 | 1.55 | 1 |
| Justierscheibe, Rondelle réglage, Adjusting shim | LF 3605.002 | 0.68 | 1/4* | LF 3605.002 | 0.68 | 1/4* | | LF 3623.202 | 11.80 | 1 |
| Anker, Ancre, Anchor | LF 3623.102 | 8.50 | 1 | LF 3623.102 | 8.50 | 1 | | LF 3806.243 | 0.08 | 1/100* |
| Gewindekleber, Frein filet, Threadlocker | LF 3806.243 | 0.08 | 1/100* | LF 3806.243 | 0.08 | 1/100* | | | | |

| | | | | | | | |
|--------------------------|----------|-----------------------|--------------|-----------------------|--------------|-----------------------|--------------|
| T = 88mm Standard | 1 Set | LF 3623.105.4~ | 20.50 | LF 3623.205.4~ | 21.95 | LF 3623.505.4~ | 19.20 |
| | ≥100 Set | LF 3623.105.6 | 19.47 | LF 3623.205.6 | 20.82 | LF 3623.505.6 | 18.03 |

| | | | | | | | |
|----------------------|-------|-----------------------|--------------|-----------------------|--------------|-----------------------|--------------|
| T = 133mm XXL | 1 Set | LF 3623.115.4~ | 24.00 | LF 3623.225.4~ | 25.45 | LF 3623.555.4~ | 22.70 |
|----------------------|-------|-----------------------|--------------|-----------------------|--------------|-----------------------|--------------|

| Art. / Code | Détail | ☑* | CHF |
|---------------|-----------|-----|-------|
| LF 1541.002.1 | A | 100 | 38.00 |
| LF 1541.003.1 | C | 100 | 39.00 |
| LF 1560.003.1 | B | 100 | 28.00 |
| LF 1720.002.1 | A / B / C | 1 | 35.50 |
| LF 3605.002.1 | A / B | 1 | 2.70 |
| LF 3806.243.1 | A / B | 1 | 7.95 |



Bohrlocherstellung ohne Schlag. Isolations- und Leichtbausteine nur auf Anfrage.
 Percage sans percussion. Briques légères pour maçonnerie seulement sur demande.
 Hole drilling without hammer drill. Insulating bricks and light bricks only on request.

Inox A2

| | | | | |
|----------------------|----------------------|---------------------|--|--------------|
| Bohrer, Méche, Drill | LF 2060.160.3 | Ø 16mm, Quadro SDS+ | | 45.00 |
| | LF 2060.200.3 | Ø 20mm, Quadro SDS+ | | 49.00 |

Bestellung Commande Order

Kunde, Client, Customer: _____

Kom., Commission: _____

Händler, Distributeur, Dealer: _____



www.lamifix.ch

lamifix@lamifix.ch

Tel: 0041 (0)55 225 48 48

Fax: 0041 (0)55 225 48 44

2016/17

Schallschutz im Holz Isolation acoustique dans le bois Noise protection in wood

5 x geschraubt, vissé, screwed Q = 250 Kg.

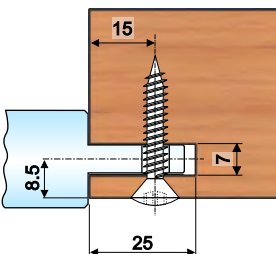
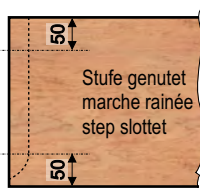
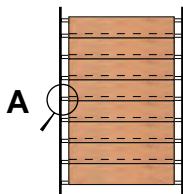
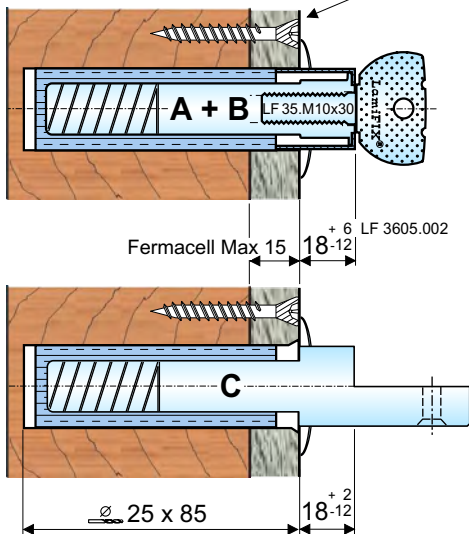

Art. / Code CHF

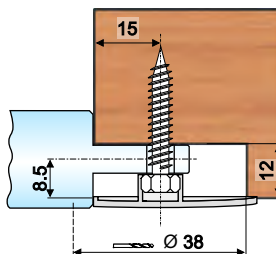
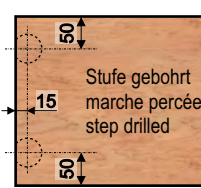
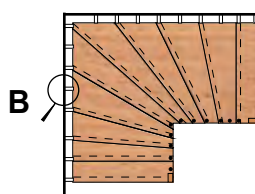

Art. / Code CHF

C = Schnellste Montage
Assemblage rapide
Fastest assembly

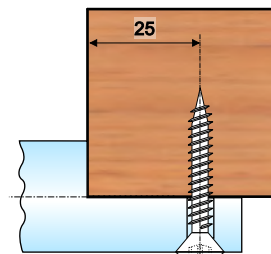
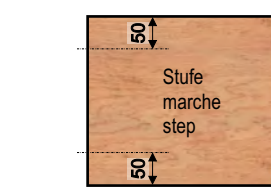

Art. / Code CHF

Set 6

| | LF 1035.130 | 3.88 | 1 | LF 1035.130 | 3.88 | 1 | | LF 1530.006 | 0.75 | 5* | LF 1530.006 | 0.75 | 5* | LF 1530.006 | 0.75 | 5* | | |
|--|-------------|------|--------|-------------|------|--------|-------------|-------------|--------|-------------|-------------|--------|-------------|-------------|--------|-------------|-------|----|
| Verbinder, Raccord, Fixing | LF 1035.130 | 3.88 | 1 | LF 1035.130 | 3.88 | 1 | | LF 1530.006 | 0.75 | 5* | LF 1530.006 | 0.75 | 5* | LF 1530.006 | 0.75 | 5* | | |
| Abdeckkappe, Capuchon, Cap | | | | LF 1435.001 | 1.55 | 1 | | LF 1541.002 | 0.38 | 1* | LF 1560.003 | 0.28 | 1* | LF 1541.003 | 0.39 | 1* | | |
| Schraube, Vis, Screw | LF 1530.006 | 0.75 | 5* | LF 1530.006 | 0.75 | 5* | LF 1530.006 | 0.75 | 5* | LF 1541.002 | 0.38 | 1* | LF 1560.003 | 0.28 | 1* | LF 1541.003 | 0.39 | 1* |
| Schraube, Vis, Screw | LF 1541.002 | 0.38 | 1* | LF 1560.003 | 0.28 | 1* | LF 1560.003 | 0.28 | 1* | LF 1620.016 | 3.95 | 1 | LF 1620.016 | 3.95 | 1 | LF 1620.016 | 3.95 | 1 |
| Schallschutzdübel, Acoustique, Silencer | LF 1620.016 | 3.95 | 1 | LF 1620.016 | 3.95 | 1 | LF 1620.016 | 3.95 | 1 | LF 1801.025 | 1.55 | 1 | LF 1801.025 | 1.55 | 1 | LF 1801.025 | 1.55 | 1 |
| Rosette, Rosace | LF 1801.025 | 1.55 | 1 | LF 1801.025 | 1.55 | 1 | LF 1801.025 | 1.55 | 1 | LF 3605.002 | 0.54 | 1/5* | LF 3605.002 | 0.54 | 1/5* | LF 1801.025 | 1.55 | 1 |
| Justierscheibe, Rondelle réglage, Adjusting shim | LF 3605.002 | 0.54 | 1/5* | LF 3605.002 | 0.54 | 1/5* | LF 3605.002 | 0.54 | 1/5* | LF 3623.102 | 8.50 | 1 | LF 3623.102 | 8.50 | 1 | LF 3623.202 | 11.80 | 1 |
| Anker, Ancre, Anchor | LF 3623.102 | 8.50 | 1 | LF 3623.102 | 8.50 | 1 | LF 3623.102 | 8.50 | 1 | LF 3806.243 | 0.08 | 1/100* | LF 3806.243 | 0.08 | 1/100* | | | |
| Gewindekleber, Frein filet, Threadlocker | LF 3806.243 | 0.08 | 1/100* | LF 3806.243 | 0.08 | 1/100* | LF 3806.243 | 0.08 | 1/100* | | | | | | | | | |

| Set 6 | 1 Set | LF 3623.106.4~ | 19.65 | LF 3623.206.4~ | 21.10 | LF 3623.506.4~ | 18.45 |
|-------|----------|----------------|-------|----------------|-------|----------------|-------|
| | ≥100 Set | LF 3623.106.6 | 18.34 | LF 3623.206.6 | 19.69 | LF 3623.506.6 | 17.04 |

| Art. / Code | Détail | pcs* | CHF |
|---------------|-----------|------|-------|
| LF 1530.006.1 | A / B / C | 100 | 15.00 |
| LF 1541.002.1 | A | 100 | 38.00 |
| LF 1541.003.1 | C | 100 | 39.00 |
| LF 1560.003.1 | B | 100 | 28.00 |
| LF 3605.002.1 | A / B | 1 | 2.70 |
| LF 3806.243.1 | A / B | 1 | 7.95 |



Inox A2

Holzspiralbohrer, Mèche pour bois, Drill for wood **LF 2001.250.3** Ø 25mm HS 95.00

Bestellung Commande Order

Kunde, Client, Customer: _____

Kom., Commission: _____

Händler, Distributeur, Dealer: _____



www.lamifix.ch

lamifix@lamifix.ch

Tel: 0041 (0)55 225 48 48

Fax: 0041 (0)55 225 48 44

2016/17

Schallschutz im Beton Isolation acoustique dans le béton Noise protection in concrete

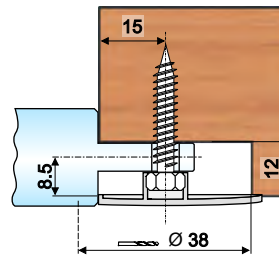
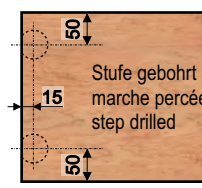
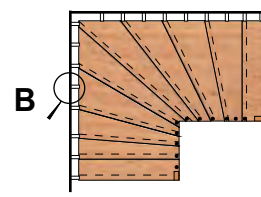
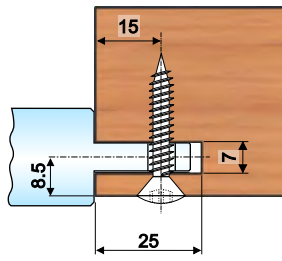
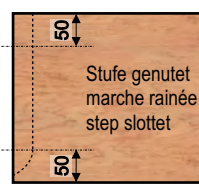
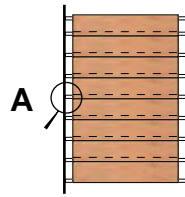
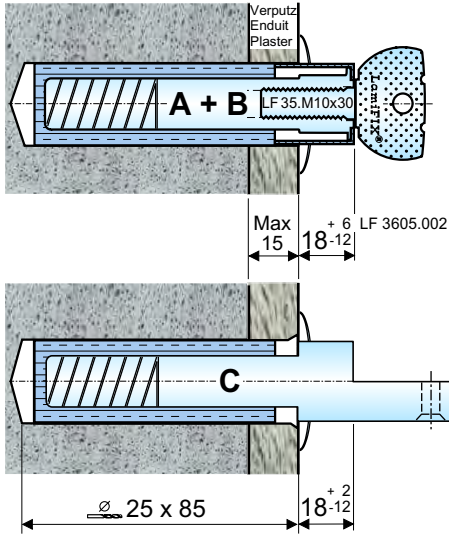

C = Schnellste Montage
Assemblage rapide
Fastest assembly

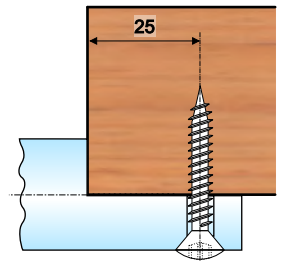
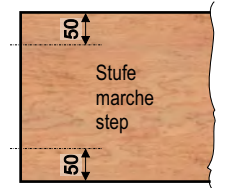

| Art. / Code | CHF | Sik/pcs | Art. / Code | CHF | Sik/pcs | Art. / Code | CHF | Sik/pcs |
|-------------|-----|---------|-------------|-----|---------|-------------|-----|---------|
|-------------|-----|---------|-------------|-----|---------|-------------|-----|---------|

Set 7

| | LF 1035.130 | 3.88 | 1 | LF 1035.130 | 3.88 | 1 | | |
|--|-------------|------|--------|-------------|------|--------|-------------|-------|
| Verbinder, Raccord, Fixing | LF 1035.130 | 3.88 | 1 | LF 1035.130 | 3.88 | 1 | | |
| Abdeckkappe, Capuchon, Cap | LF 1435.001 | 1.55 | 1 | LF 1435.001 | 1.55 | 1 | | |
| Schraube, Vis, Screw | LF 1541.002 | 0.38 | 1* | LF 1560.003 | 0.28 | 1* | LF 1541.003 | 0.39 |
| Schallschutzdübel, Acoustique, Silencer | LF 1620.016 | 3.95 | 1 | LF 1620.016 | 3.95 | 1 | LF 1620.016 | 3.95 |
| Rosette, Rosace | LF 1801.025 | 1.55 | 1 | LF 1801.025 | 1.55 | 1 | LF 1801.025 | 1.55 |
| Justierscheibe, Rondelle réglage, Adjusting shim | LF 3605.002 | 0.54 | 1/5* | LF 3605.002 | 0.54 | 1/5* | | |
| Anker, Ancre, Anchor | LF 3623.102 | 8.50 | 1 | LF 3623.102 | 8.50 | 1 | LF 3623.202 | 11.80 |
| Gewindekleber, Frein filet, Threadlocker | LF 3806.243 | 0.08 | 1/100* | LF 3806.243 | 0.08 | 1/100* | | |

| Set 7 | 1 Set | LF 3623.107.4~ | 18.90 | LF 3623.207.4~ | 20.35 | LF 3623.507.4~ | 17.70 |
|-------|----------|----------------|-------|----------------|-------|----------------|-------|
| | ≥100 Set | LF 3623.107.6 | 17.59 | LF 3623.207.6 | 18.94 | LF 3623.507.6 | 16.29 |

| Art. / Code | Détail | ☒* | CHF |
|---------------|--------|-----|-------|
| LF 1541.002.1 | A | 100 | 38.00 |
| LF 1541.003.1 | C | 100 | 39.00 |
| LF 1560.003.1 | B | 100 | 28.00 |
| LF 3605.002.1 | A / B | 1 | 2.70 |
| LF 3806.243.1 | A / B | 1 | 7.95 |

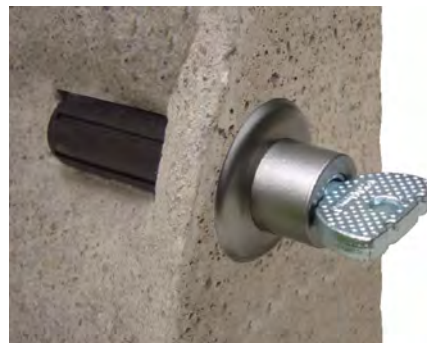

Inox A2

| Bohrer, Méche, Drill | LF 2060.250.3 | Ø 25mm, Quadro SDS+ | 62.00 |
|--|---------------|---------------------|--------|
| Armierungsbohrer, Méche béton armé, Rebar cutter | LF 2070.250.3 | Ø 25mm, SDS+ | 115.00 |

24 Weitere Werkzeuge, plus d'outils, more tools 45

Bestellung Commande Order

Kunde, Client, Customer: _____

Kom., Commission: _____

Händler, Distributeur, Dealer: _____

www.lamifix.ch

lamifix@lamifix.ch

Tel: 0041 (0)55 225 48 48

Fax: 0041 (0)55 225 48 44



2016/17

Schallschutz im Ziegelstein Isolation acoustique dans la brique Noise protection in brick

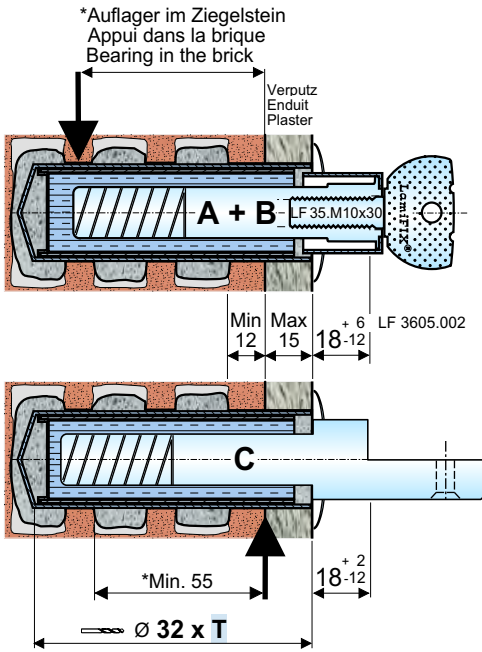

A

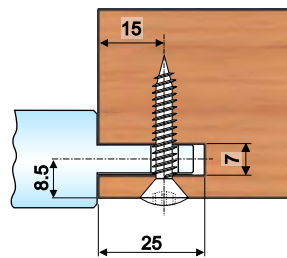
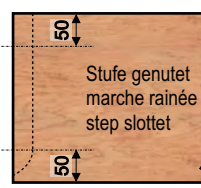
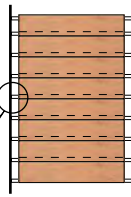

Art. / Code CHF

B

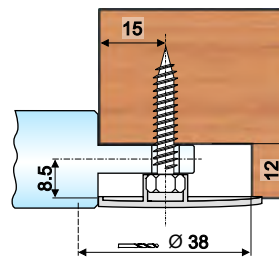
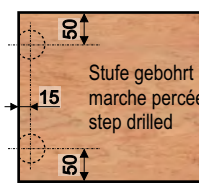
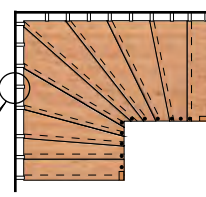

Art. / Code CHF

C

Schnellste Montage
Assemblage rapide
Fastest assembly

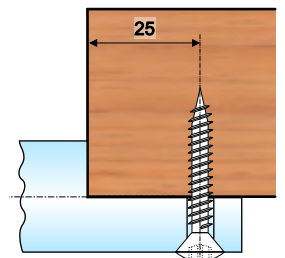
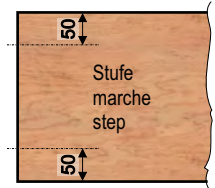

Art. / Code CHF

Set 8 + 9

| | | | |
|---|-------------|-------------|--------|
| Verbinder, Raccord, Fixing | LF 1035.130 | 3.88 | 1 |
| Abdeckkappe, Capuchon, Cap | LF 1541.002 | 0.38 | 1* |
| Schraube, Vis, Screw | LF 1620.016 | 3.95 | 1 |
| Schallschutzdübel, Acoustique, Silencer | LF 1621... | 3.60 - 3.95 | 1 |
| Rohrhülse, Douille tube, -sleeve | LF 1710.032 | 3.55 - 3.90 | 1 |
| Siebhülse, Douille de passoire, Screen tube | LF 1720.002 | 5.07 | 1/7* |
| Mörtel, Mortier chimique, Injection mortar (F120) | LF 1801.025 | 1.55 | 1 |
| Rosette, Rosace | LF 3605.002 | 0.68 | 1/4* |
| Justierscheibe, Rondelle réglage, Adjusting shim | LF 3623.102 | 8.50 | 1 |
| Anker, Ancre, Anchor | LF 3806.243 | 0.08 | 1/100* |
| Gewindekleber, Frein filet, Threadlocker | | | |

| A | |
|-------------|-------------|
| Art. / Code | CHF |
| LF 1035.130 | 3.88 |
| LF 1541.002 | 0.38 |
| LF 1620.016 | 3.95 |
| LF 1621... | 3.60 - 3.95 |
| LF 1710.032 | 3.55 - 3.90 |
| LF 1720.002 | 5.07 |
| LF 1801.025 | 1.55 |
| LF 3605.002 | 0.68 |
| LF 3623.102 | 8.50 |
| LF 3806.243 | 0.08 |

| B | |
|-------------|-------------|
| Art. / Code | CHF |
| LF 1035.130 | 3.88 |
| LF 1435.001 | 1.55 |
| LF 1560.003 | 0.28 |
| LF 1620.016 | 3.95 |
| LF 1621... | 3.60 - 3.95 |
| LF 1710.032 | 3.55 - 3.90 |
| LF 1720.002 | 5.07 |
| LF 1801.025 | 1.55 |
| LF 3605.002 | 0.68 |
| LF 3623.102 | 8.50 |
| LF 3806.243 | 0.08 |

| C | |
|-------------|-------------|
| Art. / Code | CHF |
| LF 1541.003 | 0.39 |
| LF 1620.016 | 3.95 |
| LF 1621... | 3.60 - 3.95 |
| LF 1710.032 | 3.55 - 3.90 |
| LF 1720.002 | 5.07 |
| LF 1801.025 | 1.55 |
| LF 3623.202 | 11.80 |

Set 8 T = 108mm

1 Set ≥100 Set

| | |
|----------------|-------|
| LF 3623.108.4~ | 31.25 |
| LF 3623.108.6 | 29.55 |

| | |
|----------------|-------|
| LF 3623.208.4~ | 32.70 |
| LF 3623.208.6 | 30.95 |

| | |
|----------------|-------|
| LF 3623.508.4~ | 29.90 |
| LF 3623.508.6 | 28.10 |

Set 9 T = 128mm

1 Set ≥100 Set

| | |
|----------------|-------|
| LF 3623.109.4~ | 32.60 |
| LF 3623.109.6 | 30.30 |

| | |
|----------------|-------|
| LF 3623.209.4~ | 34.05 |
| LF 3623.209.6 | 31.65 |

| | |
|----------------|-------|
| LF 3623.509.4~ | 30.85 |
| LF 3623.509.6 | 28.85 |

| Art. / Code | Détail | ☑* | CHF |
|---------------|-----------|-----|-------|
| LF 1541.002.1 | A | 100 | 38.00 |
| LF 1541.003.1 | C | 100 | 39.00 |
| LF 1560.003.1 | B | 100 | 28.00 |
| LF 1720.002.1 | A / B / C | 1 | 35.50 |
| LF 3605.002.1 | A / B | 1 | 2.70 |
| LF 3806.243.1 | A / B | 1 | 7.95 |



Bohrlocherstellung ohne Schlag. Isolations- und Leichtbausteine nur auf Anfrage.
Perçage sans percussion. Briques légères pour maçonnerie seulement sur demande.
Hole drilling without hammer drill. Insulating bricks and light bricks only on request.

Inox A2

Bohrer, Méche, Drill

LF 2060.160.3
LF 2070.320.3

Ø 16mm, Quadro SDS+
Ø 32mm, SDS+



45.00
125.00

Weitere Werkzeuge, plus d'outils, more tools

Bestellung Commande Order

Kunde, Client, Customer: _____

Kom., Commission: _____

Händler, Distributeur, Dealer: _____



www.lamifix.ch

lamifix@lamifix.ch

Tel: 0041 (0)55 225 48 48

Fax: 0041 (0)55 225 48 44

2016/17

Befestigung in Stahlwange Fixation dans limon en acier Fastener in steel stringer

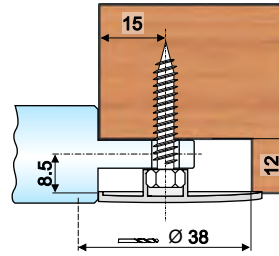
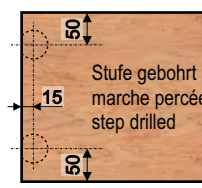
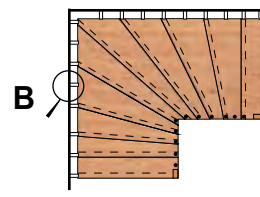
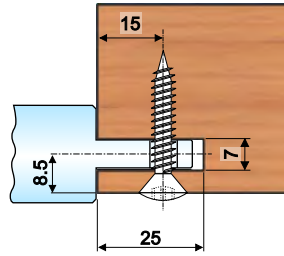
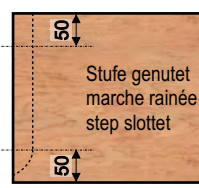
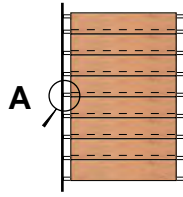
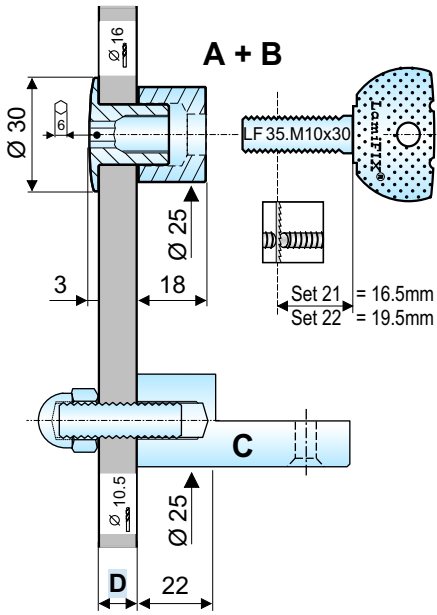

C = Schnellste Montage
Assemblage rapide
Fastest assembly

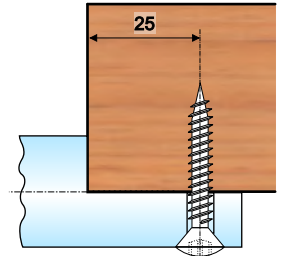
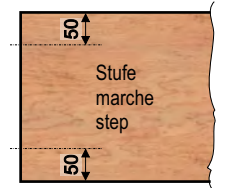

Art. / Code CHF Art. / Code CHF Art. / Code CHF

Set 21 + 22

| | LF 1035.130 | 3.88 | 1 | LF 1035.130 | 3.88 | 1 | LF 1541.003 | 0.39 | 1* |
|--|-------------|------|----|-------------|------|--------|---------------|-------------|--------|
| Verbinder, Raccord, Fixing | LF 1035.130 | 3.88 | 1 | LF 1035.130 | 3.88 | 1 | LF 1541.003 | 0.39 | 1* |
| Abdeckkappe, Capuchon, Cap | LF 1541.002 | 0.38 | 1* | LF 1435.001 | 1.55 | 1 | LF 1571.0 . . | 0.80 - 1.00 | 1 |
| Schraube, Vis, Screw | LF 1541.002 | 0.38 | 1* | LF 1560.003 | 0.28 | 1* | LF 1572.010 | 1.90 | 1* |
| Gewindestift, Vis sans tête, Allen set screw | | | | | | | | | |
| Hutmutter, Écrou borgne, Cap nut | Inox A2 | | | LF 1571.998 | 2.40 | 1 | LF 3625.022 | 11.20 | 1 |
| Zuschnitt, Coupe, Cutting | | | | LF 1571.998 | 2.40 | 1 | LF 3806.243 | 0.08 | 1/100* |
| Distanz, Distance | Inox A2 | | | LF 3624.018 | 4.95 | 1 | | | |
| Rundmutter, Écrou rond | Inox A2 | | | LF 3624.018 | 4.95 | 1 | | | |
| Gewindekleber, Frein filet, Threadlocker | | | | LF 3813.030 | 8.50 | 1 | | | |
| | | | | LF 3806.243 | 0.08 | 1/100* | | | |

| Set | D | 1 Set | LF | 20.20 | LF | 21.65 | LF | 14.40 |
|--------|--------------|----------|----------------|-------|----------------|-------|----------------|-------|
| Set 21 | D = 6 - 9mm | 1 Set | LF 3614.121.4~ | 20.20 | LF 3614.221.4~ | 21.65 | LF 3614.521.4~ | 14.40 |
| | | ≥100 Set | LF 3614.121.6 | 19.00 | LF 3614.221.6 | 20.35 | LF 3614.521.6 | 13.67 |
| Set 22 | D = 9 - 12mm | 1 Set | LF 3614.122.4~ | 20.20 | LF 3614.222.4~ | 21.65 | LF 3614.522.4~ | 14.60 |
| | | ≥100 Set | LF 3614.122.6 | 19.00 | LF 3614.222.6 | 20.35 | LF 3614.522.6 | 13.87 |

| Art. / Code | Détail | 1* | CHF |
|---------------|-----------|-----|-------|
| LF 1541.002.1 | A | 100 | 38.00 |
| LF 1541.003.1 | C | 100 | 39.00 |
| LF 1560.003.1 | B | 100 | 28.00 |
| LF 1572.010.1 | C | 10 | 19.00 |
| LF 3806.243.1 | A / B / C | 1 | 7.95 |



Eindrehwerkzeug, Outil à visser, Screw tool **LF 2150.030.3** 37.00 **LF 2151.036.3** 37.00

Bestellung Commande Order

Kunde, Client, Customer: _____

Kom., Commission: _____

Händler, Distributeur, Dealer: _____

www.lamifix.ch

lamifix@lamifix.ch

Tel: 0041 (0)55 225 48 48

Fax: 0041 (0)55 225 48 44



2016/17

Befestigung an VSG Glas
Fixation dans verre de sécurité feuilleté
Fastener in laminated safety glass

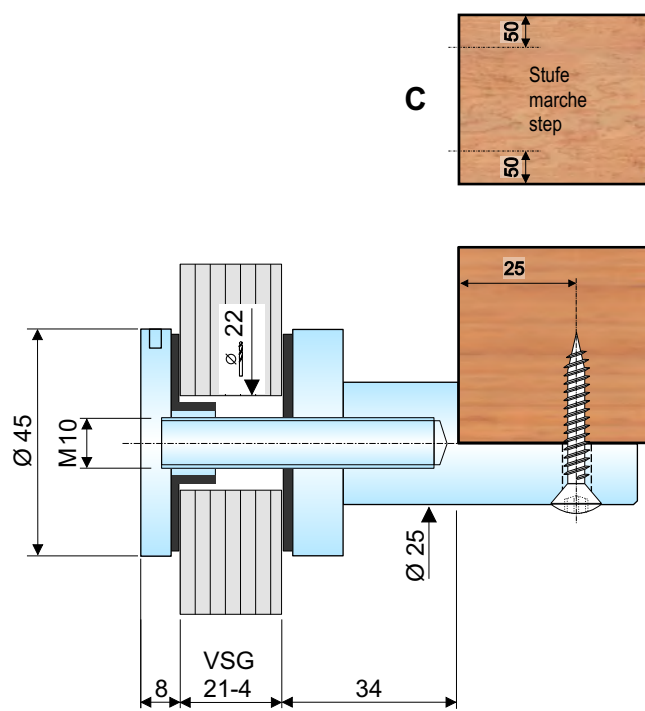

Art. / Code

CHF



Set 50

| | Art. / Code | CHF | |
|--|---------------------|-------|--------|
| Schraube, Vis, Screw | LF 1541.003 | 0.39 | 1* |
| Auflager, Raccord, Step holder | Inox A2 LF 3625.022 | 11.20 | 1 |
| Glaspunkthalter, Porte-verre, Glass holder | Inox A2 LF 4150.450 | 28.00 | 1 |
| Gewindekleber, Frein filet, Threadlocker | LF 3806.243 | 0.08 | 1/100* |

Set 50

| | | | |
|----------|----------------|-------|--|
| 1 Set | LF 4150.550.4~ | 39.70 | |
| ≥100 Set | LF 4150.550.6 | 37.70 | |

| Art. / Code | Détail | 📦* | CHF |
|---------------|--------|-----|-------|
| LF 1541.003.1 | C | 100 | 39.00 |
| LF 3806.243.1 | C | 1 | 7.95 |

| | | | |
|--|---------------|-------|--|
| Hakenschlüssel, Clé à ergot, Hook wrench | LF 4150.451.3 | 37.00 | |
|--|---------------|-------|--|



VSG Glas, direkt bei:
Verre de sécurité, directement chez:
Safety glass, directly by:

Glas Trösch AG
 Beratung
 CH-4922 Bützberg

Tel 0041 (0)62 958 53 81
 Fax 0041 (0)62 958 53 90
 Email beratung@glastroesch.ch

Glas Trösch AG
 Sicherheitsglas
 CH-9015 St. Gallen Winkeln

Tel 0041 (0)71 313 93 93
 Fax 0041 (0)71 313 93 83
 Email vsg-st-gallen@glastroesch.ch

Glas Trösch AG
 Swissslamex
 CH-4922 Bützberg

Tel 0041 (0)62 958 53 00
 Fax 0041 (0)62 958 53 01
 Email swissslamex@glastroesch.ch

Montageanleitung für seitliche Stufenbefestigungen
 Instruction de montage pour fixations latérales de marches
 Mounting instruction for lateral step fixings
 Istruzioni per il montaggio, fissaggio laterale dei gradini



1

25
 $\varnothing 40$

Schablone herstellen
 Fabriquez gabarit de perçage
 Fabricate a drill jig
 Fabricare una dima

2

LF 2115.040

Schablone anschrauben
 Vissez le gabarit de perçage
 Screw on drill jig
 Fissare la dima

3

LF 2116.040

Führungshülse einsetzen
 Insérez le douille de guidage
 Insert guide bush
 Posizionare la bussola guida

4

LF 2117.040

Ev. mit Ring anschrauben
 Ev. vissez avec l'anneau
 Ev. screw on with ring
 Ev. Fissare con anello

5

LF 2119...
 LF 2120...
 LF 2060...
 LF 2070...

Bohrbüchsen auf Bohrer schieben
 Mettez le canon de perçage sur la mèche
 Pull drill guide over drill
 Inserire la bussola sul trapano

6

Alle Positionen bohren
 Percez toutes les positions
 Drill holes on all positions
 Eseguire tutti i fori

7

Bolzen einbauen
 Installez les boulons
 Install fittings
 Installare i bulloni

Set Nr:
 5 / 7 / 8 / 9

8

Rosetten umplatzieren
 Déplacez les rosaces
 Move supports for fixing
 Riposizionare le rosette

Zentrierung einsetzen
 Insérez la douille de centrage
 Sleeve insert
 Inserire il manicotto

9

Für letzte Bohrungen, 3 - 6 wiederholen
 Pour dernier perçages, répétez 3 - 6
 For last drill holes, repeat 3 - 6
 Per ultime perforazioni, ripetere 3 - 6

Sichern
 Sécurisez
 Secure
 Bloccare

10

T
 0 bis 18 mm

T = Mindest Einbautiefe
 T = Profondeur de montage minimale
 T = Minimum mounting depth
 T = Profondità minimale

11

18 - 24
 LF 3605.002
 18 - 20

Max. 3 Scheiben zum Ausgleichen
 Max. 3 rondelles pour réglage
 Max. 3 adjusting shims to adjust
 Max. 3 rondelle distanziatrice

12

LF 3601...
 LF 1801.025
 LF 3806.243.1

Hülsen, Rosetten + Verbinder montieren
 Couvercles, rosaces + élém. d'assemblages
 Mount cover, rosettes + fixing element
 Inserire le rosette sui legami avvitare i perni

* Komplet einerschrauben (Gewindespiel aufheben)
 Vissez complètement (supprimez la tolérance filet)

Screw in completely (remove thread tolerance)
 Avvitare completo (sopprimere tolleranza filetto)

Bestellung Commande Order

Kunde, Client, Customer: _____

Kom., Commission: _____

Händler, Distributeur, Dealer: _____



www.lamifix.ch





































lamifix@lamifix.ch

Tel: 0041 (0)55 225 48 48

Fax: 0041 (0)55 225 48 44

2016/17

Werkzeug, Outils, Tools

| | Art. / Code | | | | | | | |
|---|--|---|---|--------------------------------------|---------------------------------|--------|---|---|
|  | Bohrer für Detail B Mèche pour détail B Drill for detail B | LF 2011.380.3 → 1435.001 + 1436. ... | Ø 38mm | HW | 1 | 93.00 |   | |
| |  | Bohrer für Holz Mèche pour bois Drill for wood | LF 2001.250.3 → Set 1 / 2 / 3624 | Ø 25mm | HS | 1 | 95.00 |  |
| | |  | Bohrer Quadro SDS+ Mèche Drill | LF 2060.160.3 → Set 5 / 8 / 9 | Ø 16mm | HW | 1 | 45.00 |
| | LF 2060.200.3 → Set 5 | | Ø 20mm | HW | 1 | 49.00 |  | |
| | LF 2060.250.3 → Set 7 | | Ø 25mm | HW | 1 | 62.00 |  | |
|  | Armierungsbohrer Mèche pour béton armé Rebar cutter | LF 2070.200.3 → Set 5 | Ø 20mm | HW | 1 | 99.00 |  | |
| | | LF 2070.250.3 → Set 7 | Ø 25mm | HW | 1 | 115.00 |  | |
| | Bohrer für Ziegelstein Mèche pour briques Drill for bricks | LF 2070.320.3 → Set 8 + 9 | Ø 32mm | HW | 1 | 125.00 |  | |
|  | Rosetten z. Fixieren der Bohrschablone Rosaces pour fixer le gabarit de perçage Screwing supports for fixing drill jig | LF 2115.040.3 | Ø 40mm | | 2 | 59.00 |  | |
| |  | Führungshülse für Bohrbüchsen Douille de guidage pour canon de perçage Guide bush for drill guide | LF 2116.040.3 | | gehärtet trempée hardened | 1 | 45.50 |  |
|  | | Anschraubring für Führungshülse Anneau pour douille de guidage Screwing ring for guide bush | LF 2117.040.3 | | | 1 | 32.00 |  |
|  | Bohrbüchse für Holzbohrer Canon de perçage pour mèche pour bois Drill guide for wood drill | LF 2118.250.3 → 2001.250 | Ø 25mm | gehärtet trempée hardened | 1 | 38.50 |  | |
| |  | Bohrbüchse für Steinbohrer Canon de perçage p. mèche pour pierre Drill guide for rock drill | LF 2119.160.3 → 2060.160 | Ø 16mm | gehärtet trempée hardened | 1 | 38.50 |  |
| | | LF 2119.200.3 → 2060.200 | Ø 20mm | gehärtet trempée hardened | 1 | 38.50 |  | |
| | | LF 2119.250.3 → 2060.250 | Ø 25mm | gehärtet trempée hardened | 1 | 38.50 |  | |
|  | Bohrbüchse für Armierungsbohrer Canon de perçage p. mèche pour fer à béton Drill guide for rebar cutter | LF 2120.200.3 → 2070.200 | Ø 20mm | gehärtet trempée hardened | 1 | 38.50 |  | |
| | | LF 2120.250.3 → 2070.250 | Ø 25mm | gehärtet trempée hardened | 1 | 38.50 |  | |
|  | Bohrbüchse für Ziegelstein Canon de perçage pour briques Drill guide for bricks | LF 2120.320.3 → 2070.320 | Ø 32mm | gehärtet trempée hardened | 1 | 38.50 |  | |
| | Set bestehend aus Set composé de Set consisting of | LF 2121.001.4 | LF 2115.040 - 2117.040 + LF 2118.250 - 2120.320 | | | 390.00 |  | |
| | Einzel-Set mieten Set individuel à louer Individual set to rent | LF 2121.999.4 | | pro Woche par semaine per week | | 20.00 |  | |
|  | Eindrehwerkzeug Outil à visser Screw tool | LF 2150.030.3 ○ 9mm | → LF 30 + LF 35 | | 1 | 37.00 |  | |
| | | LF 2150.036.3 ○ 9mm | → Set 1 / 2 / 3624 | A + B | 1 | 37.00 |  | |
| | | LF 2151.036.3 ○ 9mm | → Set 1 / 2 / 3624 | C | 1 | 37.00 |  | |
|  | Fräser für Nute, Detail A Fraise à rainurer 7 x 25mm détail A Cutter for grooving detail A | LF 2199.105.3 | Ø 105 / 30mm | HW | 1 | 329.00 |  | |

Bestellung Commande Order

Kunde, Client, Customer: _____

Kom., Commission: _____

Händler, Distributeur, Dealer: _____

www.lamifix.ch

lamifix@lamifix.ch

Tel: 0041 (0)55 225 48 48

Fax: 0041 (0)55 225 48 44



2016/17

Ø 10



Hartholz
Bois dur
Hardwood
☑ > 165 x 45

Ohne Verschraubung
Sans vissage
Without screwing

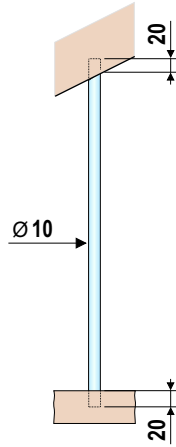

Mit Verschraubung
Avec vissage
With screwing

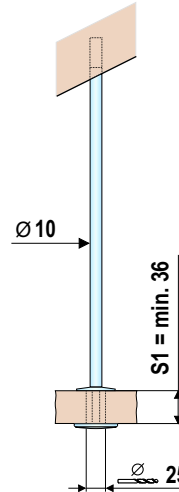

Mit Verschraubung
Avec vissage
With screwing

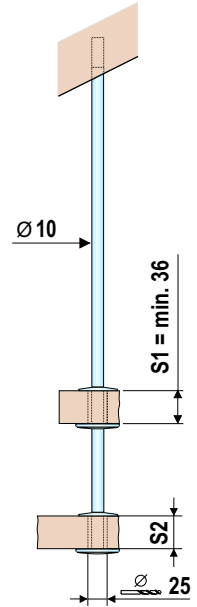

| Art. / Code | Stk. pcs | CHF | Stk. pcs | CHF | Stk. pcs | CHF | |
|---|----------|----------|-----------------------------|---------------|-----------------------|--------------|------|
| LF 3905.097 Stange, Barre, Bar | 1m | 1 | 6.65 | Set 31 | | | |
| LF 3905.997 Zuschnitt, Coupe, Cutting | 1 | 2.40 | Set 32 | | | | |
| Set 31 / 32 | | | | | | | |
| LF 1441.010 Muffe, Manchon, Thread | | | 1* | 0.88 | 1* | 0.88 | |
| LF 3803.037 End-Rosette, -terminale M10 | | | 1 | 9.95 | 1 | 9.95 | |
| LF 3901.001 Holzhülse, Douille, Bush | | | 1* | 2.00 | 1* | 2.00 | |
| LF 3911.031 Deck-Rosette, Ring cover M10 | | | 1 | 7.20 | 1 | 7.20 | |
| LF 3912.031 Deck-Rosette, Ring cover M16 | | | | | 1 | 8.50 | |
| LF 3912.037 Trag-Rosette, -portante M16 | | | | | 1 | 9.95 | |
| LF 3806.243 Gewindekleber, Frein filet | | | 1/100* | 0.08 | 1/100* | 0.08 | |
| | 1 Set | | LF 3900.031.4~ | 20.10 | LF 3900.032.4~ | 38.55 | |
| | ≥100 Set | | LF 3900.031.6 | 19.50 | LF 3900.032.6 | 37.15 | |
| Inox-Stange, Barre, Bar | | | | | | | |
| LF 3905.097 Stange, Barre, Bar | 1m | ≥100 Stk | m ¹ = 5.95 | 1 | 6.65 | 1 | 6.65 |
| LF 3905.197 Stange, Barre, Bar | 2m | ≥ 50 Stk | 11.90 m ¹ = 5.95 | 13.30 | | | |
| LF 3905.600 Stange, Barre, Bar | 6m | ≥ 20 Stk | 35.70 m ¹ = 5.95 | 39.90 | | | |
| LF 3905.997 Zuschnitt, Coupe, Cutting | | | | 1 | 2.40 | 1 | 2.40 |
| LF 3905.998 Gewindeschneiden, Fileter M10 | | | | 2 | 6.20 | 2 | 6.20 |
| LF 3905.999 Schweißen, Souder, Welding | | | | | | 1 | 6.90 |

| Art. / Code | Set | ☑* | CHF |
|---|----------------------------|----|-------|
| LF 1441.010.1 | 31 / 32 | 25 | 22.00 |
| LF 3806.243.1 | 31 / 32 | 1 | 7.95 |
| LF 3901. . . . 1 | 31 / 32 | 10 | 20.00 |
| . . .001.1 | Buche, Hêtre, Beech | | |
| . . .002.1 | Ahorn, Érable, Maple | | |
| . . .003.1 | Eiche, Chêne, Oak | | |
| . . .004.1 | Esche, Frêne, Ash | | |
| . . .005.1 | Europ. Nuss, Noyer, Walnut | | |
| . . .Auf Anfrage, Sur demande, On request | | | |

Montageanleitung für Stufenaufhängungen
 Instruction de montage pour suspension de marches
 Mounting instruction for step hangers
 Istruzioni per il montaggio del fissaggio dei gradini

Ø 10

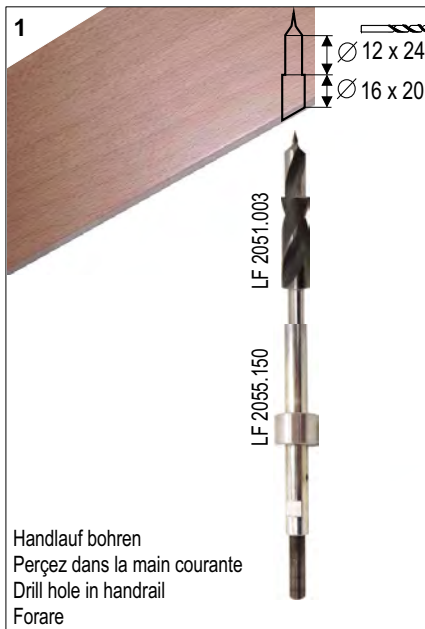

Handlauf bohren
 Percez dans la main courante
 Drill hole in handrail
 Forare

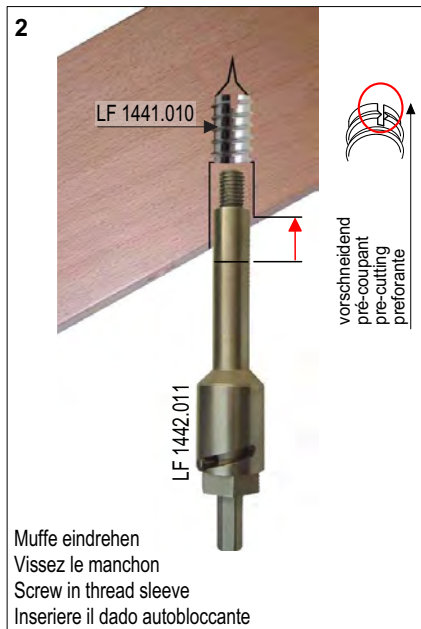

Muffe eindrehen
 Vissez le manchon
 Screw in thread sleeve
 Inserire il dado autobloccante



Holzhülse einkleben + abschleifen
 Collez la douille en bois + poncez
 Glue wood bush + grind it
 Incollare bossolo + levigare



Stange eindrehen
 Vissez la barre
 Screw in bar
 Avvitare barra



Ausrichten + Rosette konter-verschrauben
 Ajustez + contrevissez la rosace
 Adjust + counter-screw rosette
 Allineare + avvitare rosetta

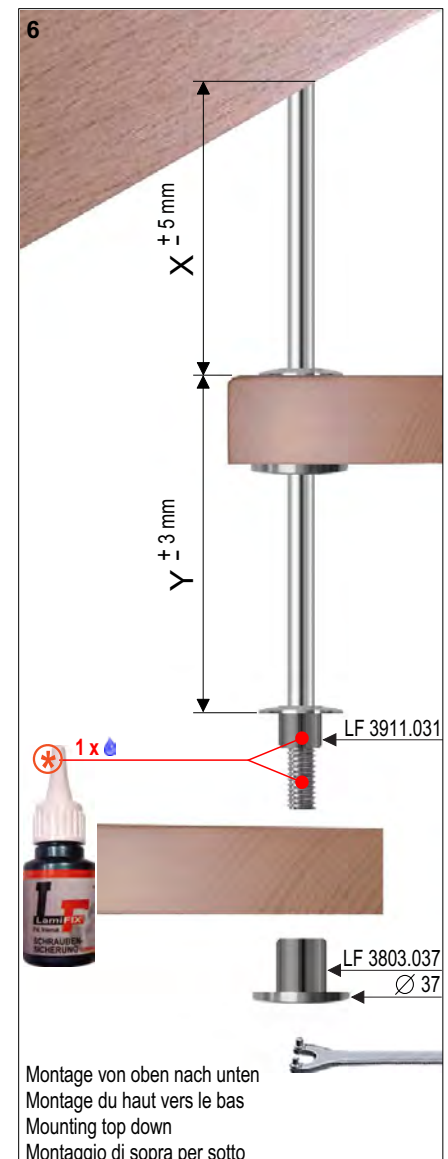

Montage von oben nach unten
 Montage du haut vers le bas
 Mounting top down
 Montaggio di sopra per sotto

* Alle Verschraubungen wieder lösbar sichern.
 Sécurisez le vissage de manière re-devissable.

Secure all screwings afresh unlockable.
 Bloccare l'avvitamento alla maniera svitabile.

Bestellung Commande Order

Kunde, Client, Customer: _____

Kom., Commission: _____

Händler, Distributeur, Dealer: _____



www.lamifix.ch

lamifix@lamifix.ch

Tel: 0041 (0)55 225 48 48

Fax: 0041 (0)55 225 48 44

2016/17

Ohne Verschraubung
Sans vissage
Without screwing

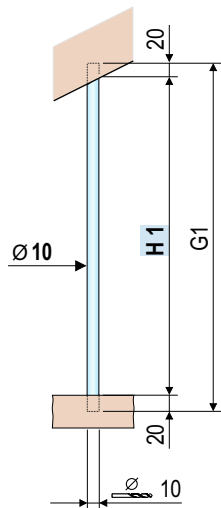

Mit Verschraubung
Avec vissage
With screwing

Set 31

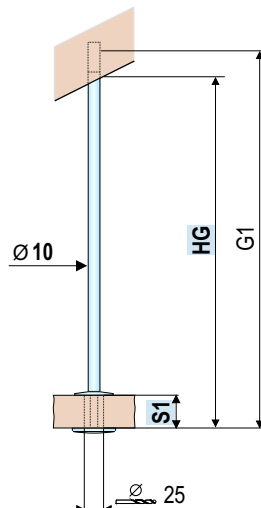

Set 32

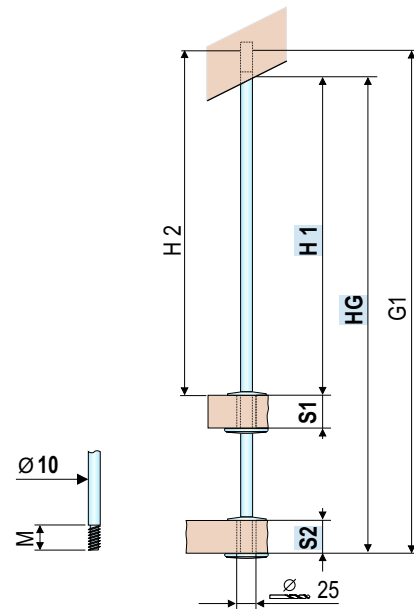

| No | H1 | +40 | =G1 | Stk | HG | +35 | =G1 | S1 | -6 | =M | Stk | HG | +35 | =G1 | H1 | +39 | =H2 | S2 | -6 | =M | Stk | |
|----|----|-----|-----|-----|----|-----|-----|----|----|----|-----|----|-----|-----|----|-----|-----|----|----|----|-----|--|
| 1 | | +40 | | | | +35 | | | -6 | | | | +35 | | | +39 | | | | -6 | | |
| 2 | | +40 | | | | +35 | | | -6 | | | | +35 | | | +39 | | | | -6 | | |
| 3 | | +40 | | | | +35 | | | -6 | | | | +35 | | | +39 | | | | -6 | | |
| 4 | | +40 | | | | +35 | | | -6 | | | | +35 | | | +39 | | | | -6 | | |
| 5 | | +40 | | | | +35 | | | -6 | | | | +35 | | | +39 | | | | -6 | | |
| 6 | | +40 | | | | +35 | | | -6 | | | | +35 | | | +39 | | | | -6 | | |
| 7 | | +40 | | | | +35 | | | -6 | | | | +35 | | | +39 | | | | -6 | | |
| 8 | | +40 | | | | +35 | | | -6 | | | | +35 | | | +39 | | | | -6 | | |
| 9 | | +40 | | | | +35 | | | -6 | | | | +35 | | | +39 | | | | -6 | | |
| 10 | | +40 | | | | +35 | | | -6 | | | | +35 | | | +39 | | | | -6 | | |
| 11 | | +40 | | | | +35 | | | -6 | | | | +35 | | | +39 | | | | -6 | | |
| 12 | | +40 | | | | +35 | | | -6 | | | | +35 | | | +39 | | | | -6 | | |
| 13 | | +40 | | | | +35 | | | -6 | | | | +35 | | | +39 | | | | -6 | | |
| 14 | | +40 | | | | +35 | | | -6 | | | | +35 | | | +39 | | | | -6 | | |
| 15 | | +40 | | | | +35 | | | -6 | | | | +35 | | | +39 | | | | -6 | | |
| 16 | | +40 | | | | +35 | | | -6 | | | | +35 | | | +39 | | | | -6 | | |
| 17 | | +40 | | | | +35 | | | -6 | | | | +35 | | | +39 | | | | -6 | | |
| 18 | | +40 | | | | +35 | | | -6 | | | | +35 | | | +39 | | | | -6 | | |
| 19 | | +40 | | | | +35 | | | -6 | | | | +35 | | | +39 | | | | -6 | | |
| 20 | | +40 | | | | +35 | | | -6 | | | | +35 | | | +39 | | | | -6 | | |
| 21 | | +40 | | | | +35 | | | -6 | | | | +35 | | | +39 | | | | -6 | | |
| 22 | | +40 | | | | +35 | | | -6 | | | | +35 | | | +39 | | | | -6 | | |
| 23 | | +40 | | | | +35 | | | -6 | | | | +35 | | | +39 | | | | -6 | | |
| 24 | | +40 | | | | +35 | | | -6 | | | | +35 | | | +39 | | | | -6 | | |
| 25 | | +40 | | | | +35 | | | -6 | | | | +35 | | | +39 | | | | -6 | | |
| 26 | | +40 | | | | +35 | | | -6 | | | | +35 | | | +39 | | | | -6 | | |
| 27 | | +40 | | | | +35 | | | -6 | | | | +35 | | | +39 | | | | -6 | | |
| 28 | | +40 | | | | +35 | | | -6 | | | | | | | | | | | | | |
| 29 | | +40 | | | | +35 | | | -6 | | | | | | | | | | | | | |
| 30 | | +40 | | | | +35 | | | -6 | | | | | | | | | | | | | |

Bestellung Commande Order

Kunde, Client, Customer: _____

Kom., Commission: _____

Händler, Distributeur, Dealer: _____



www.lamifix.ch

lamifix@lamifix.ch

Tel: 0041 (0)55 225 48 48

Fax: 0041 (0)55 225 48 44

2016/17

Aufhängung an Weichholzbalken / Suspension en solive de bois blanc / Hanger at softwood ceiling joist

Set 99

Höhenverstellbar
Réglable en hauteur
Height adjustable $\pm 2\text{mm}$

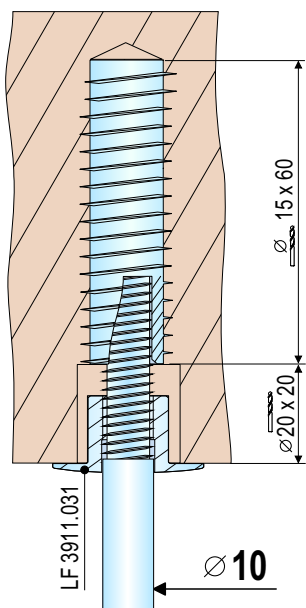

Set 100

$\pm 5\text{mm}$

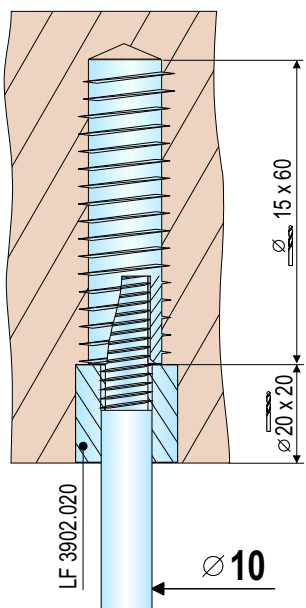

Set 101

$\pm 5\text{mm}$

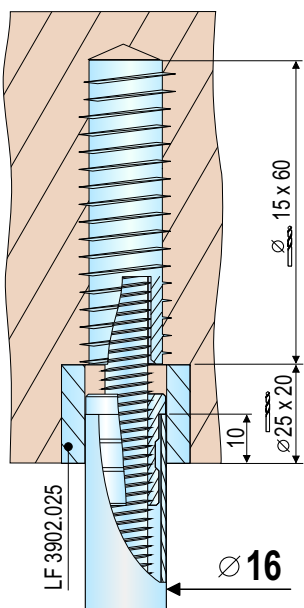

Set 102

Nicht höhenverstellbar
Non réglable en hauteur
Not height adjustable

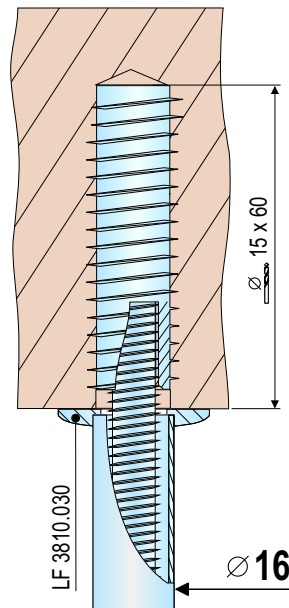

| Art. / Code | CHF | Stk. pcs | CHF | Stk. pcs | CHF | Stk. pcs | CHF | Stk. pcs | CHF |
|---------------------------------------|-------|-----------------------|------|-----------------------|------|-----------------------|------|----------|------|
| LF 1441.160 Muffe, Manchon, Thread | 3.80 | 1 | 3.80 | 1 | 3.80 | 1 | 3.80 | 1 | 3.80 |
| LF 3806.243 Gewindekleber, Adhésive | 0.08 | 1/100* | 0.08 | 1/100* | 0.08 | 1/100* | 0.08 | 1/100* | 0.08 |
| LF 3810.030 Decken-Rosette, Top cover | | | | | | | | 1 | 3.00 |
| LF 3902.020 Holzring, Douille, Bush | | 1 | 2.10 | | | | | | |
| LF 3902.025 Holzring, Douille, Bush | | | | 1 | 2.20 | | | | |
| LF 3911.031 Deck-Rosette, Ring cover | 7.20 | | | | | | | | |
| 1 Set LF 3900.099.4~ | 11.10 | LF 3900.100.4~ | 6.00 | LF 3900.101.4~ | 6.10 | LF 3900.102.4~ | 6.90 | | |
| ≥ 100 Set LF 3900.099.6 | 10.30 | LF 3900.100.6 | 5.50 | LF 3900.101.6 | 5.70 | LF 3900.102.6 | 6.50 | | |

| Art. / Code | Set | Stk. pcs | CHF |
|---------------|-----|----------|------|
| LF 3806.243.1 | 100 | 1 | 7.95 |

Eindrehwerkzeug
Outil à visser
Screw tool



| | | |
|----------------------|-----|-------|
| LF 1442.011.3 | M10 | 99.50 |
|----------------------|-----|-------|

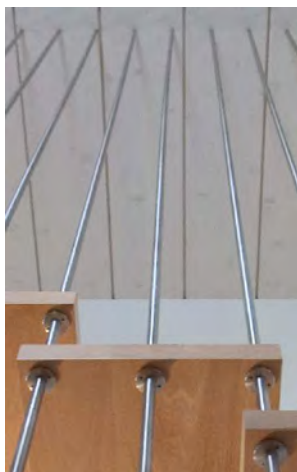

Bestellung Commande Order

Kunde, Client, Customer: _____

Kom., Commission: _____

Händler, Distributeur, Dealer: _____

www.lamifix.ch

lamifix@lamifix.ch

Tel: 0041 (0)55 225 48 48

Fax: 0041 (0)55 225 48 44



2016/17

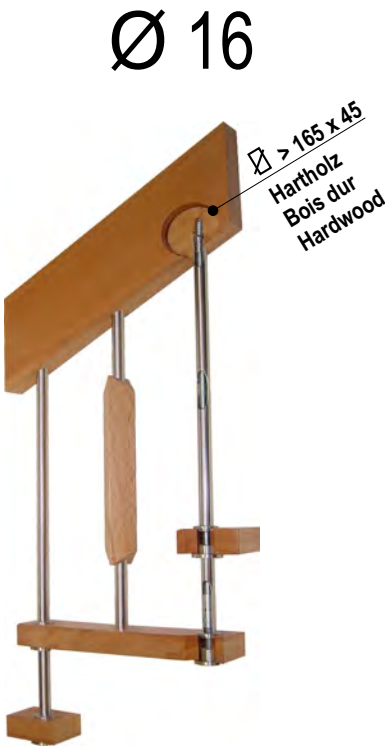

Ohne Verschraubung
Sans vissage
Without screwing

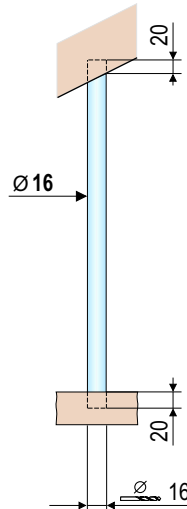

Mit Verschraubung
Avec vissage
With screwing **Set 11**

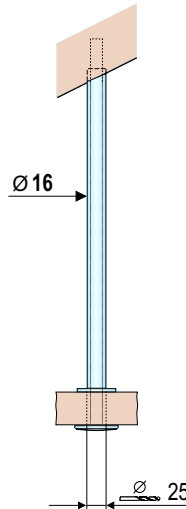

Set 12

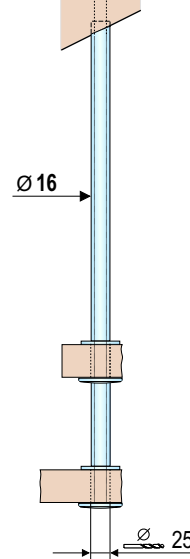

Set 13

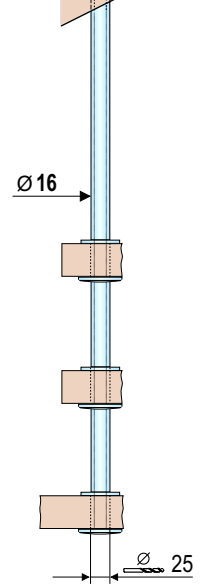

| Art. / Code | Set | Stk. pcs | CHF | Stk. pcs | CHF | Stk. pcs | CHF | Stk. pcs | CHF |
|---|----------|----------|-----------------|-----------------------|--------------|-----------------------|--------------|-----------------------|--------------|
| LF 3805.097 Rohr, tube | 1m | 1 | 6.65 | | | | | | |
| LF 3805.999 Zuschnitt, Coupe, Cutting | | 1 | 2.40 | | | | | | |
| Set 11 / 12 / 13 | | | | | | | | | |
| LF 1441.010 Muffe, Manchon, Thread | | | | 1* | 0.88 | 1* | 0.88 | 1* | 0.88 |
| LF 1455.010 Anschlag, Butée, End stop | | | | 1 | 2.90 | 1 | 2.90 | 1 | 2.90 |
| LF 1456.010 Kupplung, Accouplement | | | | | | 1 | 2.95 | 1 | 2.95 |
| LF 1456.083 Gewindestift + Kupplung | | | | | | 1 | 5.70 | 1 | 5.70 |
| LF 3802.037 Trag-Rosette, -portante | | | | | | 1 | 9.85 | 2 | 19.70 |
| LF 3803.037 End-Rosette, -terminale | | | | 1 | 9.95 | 1 | 9.95 | 1 | 9.95 |
| LF 3806.001 Höhenausgleich, Ajustage | | | | | | 1* | 0.16 | 2* | 0.32 |
| LF 3806.130 Hülse, Isolante, Silencer | | | | 1* | 0.75 | 2 | 1.50 | 3* | 2.25 |
| LF 3806.160 Rond. Isol. Silenc. Ring | | | | 2* | 0.38 | 4* | 0.76 | 6* | 1.14 |
| LF 3806.243 Gewindekleber, Adhésive | | | | 1/100* | 0.08 | 1/100* | 0.08 | 1/100* | 0.08 |
| LF 3811.030 Deck-Rosette, Ring cover | | | | 1 | 4.95 | 2 | 9.90 | 3 | 14.85 |
| | 1 Set | | | LF 3800.011.4~ | 19.90 | LF 3800.012.4~ | 41.70 | LF 3800.013.4~ | 60.70 |
| | ≥100 Set | | | LF 3800.011.6 | 19.20 | LF 3800.012.6 | 40.30 | LF 3800.013.6 | 58.60 |
| Gewindestangen mit Inbus 5mm Tiges filetées, Threaded rods | | | | | | | | | |
| LF 1571.097 Gewindestange M10 | 1m | | | 1 | 3.85 | 1 | 3.85 | 2 | 7.70 |
| LF 1571.197 Tige filetée | 2m | 6.90 | | | | | | | |
| LF 1571.300 Threaded rod | 3m | 15.00 | | | | | | | |
| LF 1571.998 Zuschnitt, Coupe, Cutting | | | | 1 | 2.40 | 1 | 2.40 | 2 | 4.80 |
| LF 1571.999 Verpressen, Pression, Stamp. | | | | 1 | 1.30 | 1 | 1.30 | 2 | 2.60 |
| Inox-Rohr, Tube | | | | | | | | | |
| LF 3805.097 Rohr, Tube | 1m | ≥100 Stk | m' = 5.95 | 1 | 6.65 | 1 | 6.65 | 1.2m | 7.95 |
| LF 3805.197 Rohr, Tube | 2m | ≥ 50 Stk | 11.90 m' = 5.95 | 13.30 | | | | | |
| LF 3805.600 Rohr, Tube | 6m | ≥ 20 Stk | 35.70 m' = 5.95 | 39.90 | | | | | |
| LF 3805.999 Zuschnitt, Coupe, Cutting | | | | 1 | 2.40 | 2 | 4.80 | 3 | 7.20 |

| Art. / Code | Set | Stk* | CHF |
|---------------|---------|------|-------|
| LF 1441.010.1 | 11 - 13 | 25 | 22.00 |
| LF 3806.001.1 | 12 + 13 | 100 | 16.00 |
| LF 3806.130.1 | 11 - 13 | 10 | 7.50 |
| LF 3806.160.1 | 11 - 13 | 100 | 19.00 |
| LF 3806.243.1 | 11 - 13 | 1 | 7.95 |

Montageanleitung für Stufenaufhängungen
 Instruction de montage pour suspension de marches
 Mounting instruction for step hangers
 Istruzioni per il montaggio del fissaggio dei gradini

Ø 16



1

Handlauf bohren
 Percez dans la main courante
 Drill hole in handrail
 Forare

2

Muffe eindrehen
 Vissez le manchon
 Screw in thread sleeve
 Inserire il dado autobloccante

3

Gewindestange mit Anschlag + Dämpfungsring
 Tige filetée avec butée + rondelle isolante
 Threaded rod with end stop top + silencer ring
 Fissare barra filettata + anello d'assorbimento

4

Ca. alle 500mm eine Dämpfungshülse
 Env. tous 500mm une douille isolante
 Approx. all 500mm one silencer bush
 Circa. tutti 500mm un anello d'assorbimento

5

Rohr, Dämpfungsring + Deck-Rosette
 Tube, rondelle isolante + rosace de haut
 Tube, silencer ring + ring cover top
 Tubo, anello + rosetta di copertura

6

Bohrungen in den Stufen Ø 25mm
 Perçages dans les marches Ø 25mm
 Drill hole in steps Ø 25mm
 Perforazioni in gradini Ø 25mm

7

Stufe montieren + nivellieren...
 Montez + nivelez la marche...
 Step mounting + levelling...
 Allineare il gradino...

8

...Rosette + Gew.-Stange konter-verschrauben
 ...contre-vissez la rosace + la tige filetée
 ...rosette + threaded rods counter-screwing
 ...avvitare rosetta

9

Alle Gewinde mind. 10mm verschrauben
 Vissez filets à min. 10mm
 Screw in all threads min. 10mm
 Avvitare min. 10mm tutti filetti

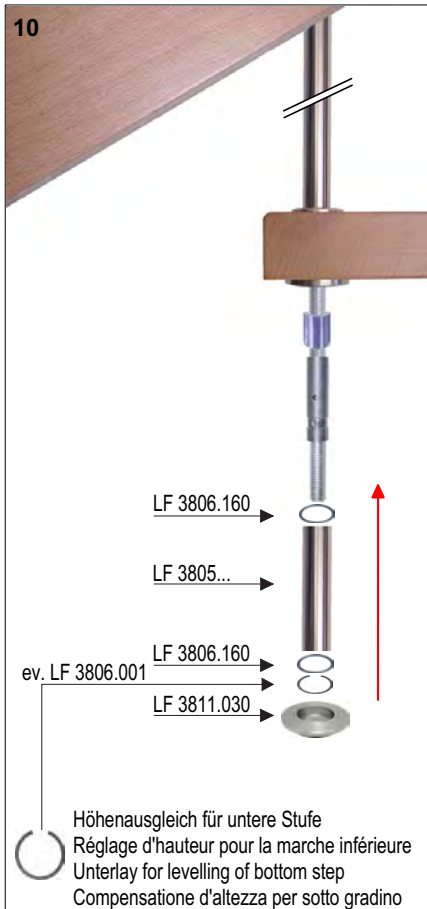

Alle Verschraubungen wieder lösbar sichern.
Sécurisez le vissage de manière re-devissable.
Secure all screwings afresh unlockable.
Bloccare l'avvitamento alla maniera svitabile.



Bestellung Commande Order

Kunde, Client, Customer: _____

Kom., Commission: _____

Händler, Distributeur, Dealer: _____



www.lamifix.ch

lamifix@lamifix.ch

Tel: 0041 (0)55 225 48 48

Fax: 0041 (0)55 225 48 44

2016/17

**Ohne Verschraubung
Sans vissage
Without screwing**

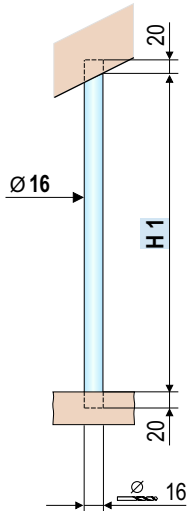

**Mit Verschraubung
Avec vissage
With screwing Set 11**

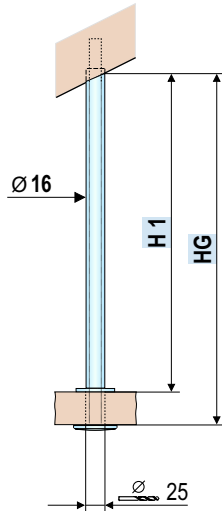

Set 12

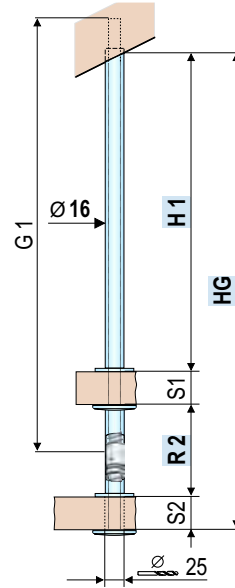

Set 13

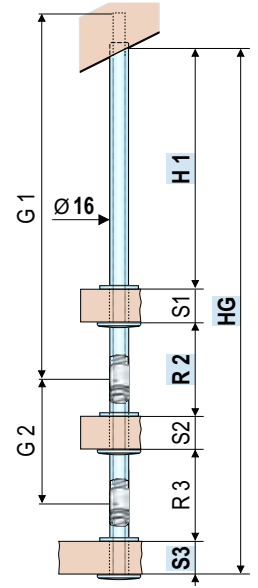

| No | H1 | +40 | =R1 | Stk | HG | +32 | =G1 | H1 | +10 | =R1 | Stk | HG | -36 | =G1 | H1 | +10 | =R1 | =R2 | Stk | HG | R2 | S3 | H1 | Stk | |
|----|----|-----|-----|-----|----|-----|-----|----|-----|-----|-----|----|-----|-----|----|-----|-----|-----|-----|----|----|----|----|-----|--|
| 1 | | +40 | | | | +32 | | | +10 | | | | -36 | | | +10 | | | | | | | | | |
| 2 | | +40 | | | | +32 | | | +10 | | | | -36 | | | +10 | | | | | | | | | |
| 3 | | +40 | | | | +32 | | | +10 | | | | -36 | | | +10 | | | | | | | | | |
| 4 | | +40 | | | | +32 | | | +10 | | | | -36 | | | +10 | | | | | | | | | |
| 5 | | +40 | | | | +32 | | | +10 | | | | -36 | | | +10 | | | | | | | | | |
| 6 | | +40 | | | | +32 | | | +10 | | | | -36 | | | +10 | | | | | | | | | |
| 7 | | +40 | | | | +32 | | | +10 | | | | -36 | | | +10 | | | | | | | | | |
| 8 | | +40 | | | | +32 | | | +10 | | | | -36 | | | +10 | | | | | | | | | |
| 9 | | +40 | | | | +32 | | | +10 | | | | -36 | | | +10 | | | | | | | | | |
| 10 | | +40 | | | | +32 | | | +10 | | | | -36 | | | +10 | | | | | | | | | |
| 11 | | +40 | | | | +32 | | | +10 | | | | -36 | | | +10 | | | | | | | | | |
| 12 | | +40 | | | | +32 | | | +10 | | | | -36 | | | +10 | | | | | | | | | |
| 13 | | +40 | | | | +32 | | | +10 | | | | -36 | | | +10 | | | | | | | | | |
| 14 | | +40 | | | | +32 | | | +10 | | | | -36 | | | +10 | | | | | | | | | |
| 15 | | +40 | | | | +32 | | | +10 | | | | -36 | | | +10 | | | | | | | | | |
| 16 | | +40 | | | | +32 | | | +10 | | | | -36 | | | +10 | | | | | | | | | |
| 17 | | +40 | | | | +32 | | | +10 | | | | -36 | | | +10 | | | | | | | | | |
| 18 | | +40 | | | | +32 | | | +10 | | | | -36 | | | +10 | | | | | | | | | |
| 19 | | +40 | | | | +32 | | | +10 | | | | -36 | | | +10 | | | | | | | | | |
| 20 | | +40 | | | | +32 | | | +10 | | | | -36 | | | +10 | | | | | | | | | |
| 21 | | +40 | | | | +32 | | | +10 | | | | -36 | | | +10 | | | | | | | | | |
| 22 | | +40 | | | | +32 | | | +10 | | | | -36 | | | +10 | | | | | | | | | |
| 23 | | +40 | | | | +32 | | | +10 | | | | -36 | | | +10 | | | | | | | | | |
| 24 | | +40 | | | | +32 | | | +10 | | | | -36 | | | +10 | | | | | | | | | |
| 25 | | +40 | | | | +32 | | | +10 | | | | -36 | | | +10 | | | | | | | | | |
| 26 | | +40 | | | | +32 | | | +10 | | | | -36 | | | +10 | | | | | | | | | |
| 27 | | +40 | | | | +32 | | | +10 | | | | -36 | | | +10 | | | | | | | | | |
| 28 | | +40 | | | | +32 | | | +10 | | | | -36 | | | +10 | | | | | | | | | |
| 29 | | +40 | | | | +32 | | | +10 | | | | -36 | | | +10 | | | | | | | | | |
| 30 | | +40 | | | | +32 | | | +10 | | | | -36 | | | +10 | | | | | | | | | |

5

Bestellung Commande Order

Kunde, Client, Customer: _____

Kom., Commission: _____

Händler, Distributeur, Dealer: _____

www.lamifix.ch

lamifix@lamifix.ch

Tel: 0041 (0)55 225 48 48

Fax: 0041 (0)55 225 48 44



2016/17

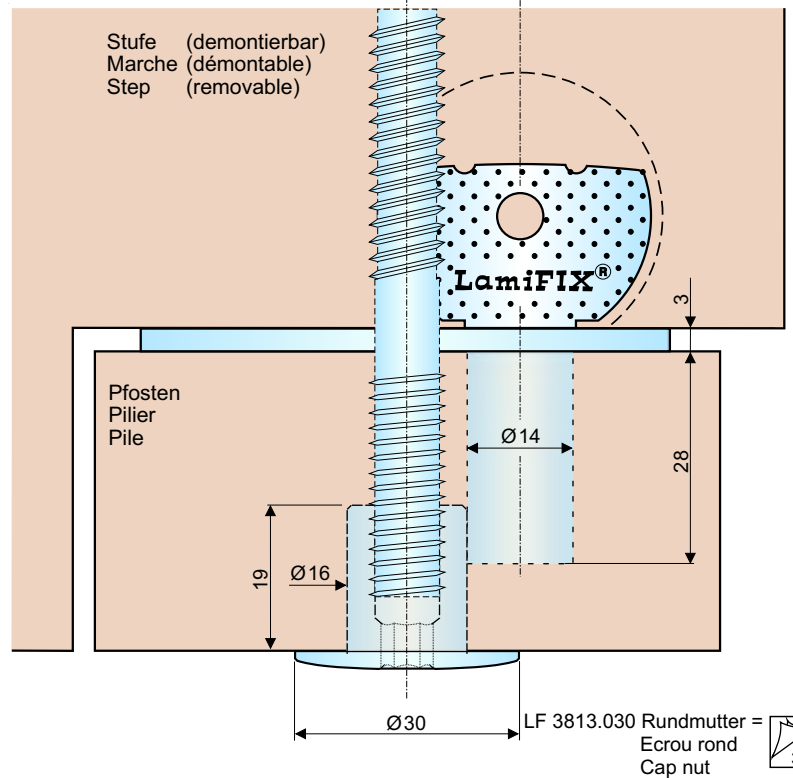
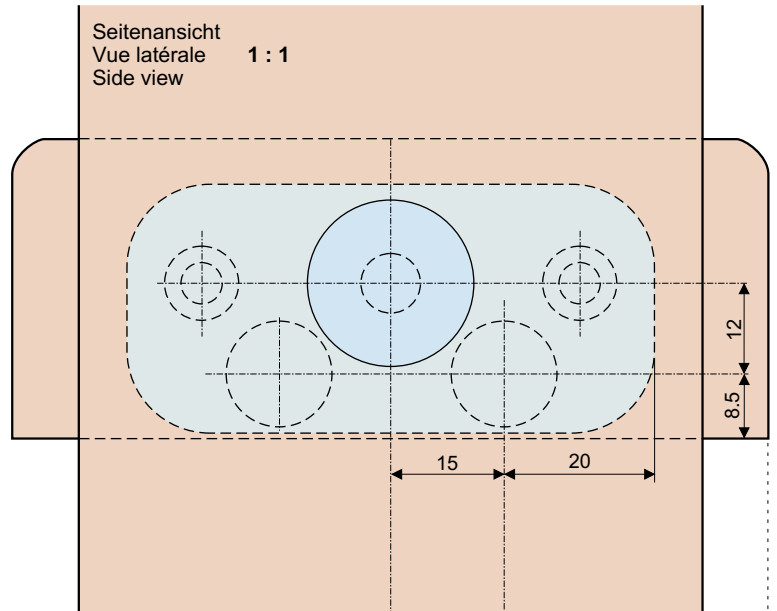

links oder rechts verwendbar
utilisable à gauche ou à droite
usable for left or right side



Set-Verschraubung zwischen Handlaufpfosten und Stufe, komplett
Set de vissage entre pilier de main courante et la marche, complet
Screwing set between pile from handrail to step, complete

| Art. | Code | Stk/pcs | CHF |
|---------------|------------|---------|-------|
| LF 4200.001.4 | 4200.001.4 | 1 | 45.00 |

Bestellung Commande Order

Kunde, Client, Customer: _____

Kom., Commission: _____

Händler, Distributeur, Dealer: _____

www.lamifix.ch

lamifix@lamifix.ch

Tel: 0041 (0)55 225 48 48

Fax: 0041 (0)55 225 48 44



2016/17

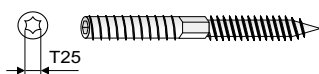
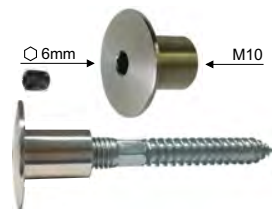

| | Art. / Code | | | | | |
|---|---------------|-------|------|--------|--|--|
| Rundmutter M10, Inox A2 Ecrous ronds M10, Inox A2 Cap nuts M10, Inox A2 | LF 3813.030.1 | Ø 30 | 1 | 8.50 | | |
| | LF 3813.030.2 | | ≥100 | 7.90 | | |
| Stockschraube M10, T25 Vis à deux filetages M10, T25 Hanger bolt M10, T25 | LF 1570.060.1 | 60mm | 10 | 4.30 | | |
| | LF 1570.060.2 | | 100 | 41.00 | | |
| | LF 1570.080.1 | 80mm | 10 | 4.50 | | |
| | LF 1570.080.2 | | 100 | 43.00 | | |
| | LF 1570.100.1 | 100mm | 10 | 5.10 | | |
| | LF 1570.100.2 | | 100 | 48.00 | | |
| | LF 1570.120.1 | 120mm | 10 | 5.80 | | |
| | LF 1570.120.2 | | 100 | 55.00 | | |
| | LF 1570.140.1 | 140mm | 10 | 7.50 | | |
| | LF 1570.140.2 | | 100 | 71.50 | | |
| | LF 1570.160.1 | 160mm | 10 | 8.50 | | |
| | LF 1570.160.2 | | 100 | 81.00 | | |
| | LF 1570.180.1 | 180mm | 10 | 10.50 | | |
| | LF 1570.180.2 | | 100 | 100.00 | | |
| | LF 1570.200.1 | 200mm | 10 | 12.40 | | |
| | LF 1570.200.2 | | 100 | 118.00 | | |

Werkzeug für Stufenaufhängungen Outils pour suspension de marches Tools for step hangers



| | | | | | | |
|--|----------------------------------|---------|----|-------|--------|--|
| Stockschraubeneindreher Outil pour vis à deux filetages Hanger bolt driver | LF 1569.010.3 | M10 | 1 | 45.50 | | |
| Stufenbohrer Mèche étagée Stepped drill | LF 2051.003.3 | Ø12/16 | HS | 1 | 148.00 | |
| | → 1441.010 + 3805... + 3900... | | | | | |
| Staketenbohrer Mèche pour barre Drill for bar | LF 2052.003.3 | Ø 10 | HS | 1 | 85.00 | |
| | → 3905... | | | | | |
| Verlängerung für Bohrer Allongement pour mèche Extension piece for drill | LF 2055.150.3 | Ø16x135 | 1 | 57.00 | | |
| | → 2051.003 + 2052.003 | | | | | |
| Eindrehwerkzeug Outil à visser Screw tool | LF 1442.011.3 | M10 | 1 | 99.50 | | |
| | → 1441.010 | | | | | |
| Stirnlochschlüssel Clé à ergots pour rosaces Face spanner for bearings | LF 3807.025.3 | | 1 | 15.00 | | |
| | → 3802.037 + 3803.037 + 3912.037 | | | | | |

| | | | | | | |
|---|---------------|--|---|--------|--|--|
| Staketenbohrlehre Gabarit de perçage pour suspension Drill jig for hanger | LF 3906.002.3 | | 1 | 390.00 | | |
|---|---------------|--|---|--------|--|--|

inkl. Bohrbüchse 16mm. Weitere Grössen auf Anfrage erhältlich.
incl. canon de perçage 16mm. Autre dim. disponibles sur demande.
incl. drill guide 16mm. Others available on request.

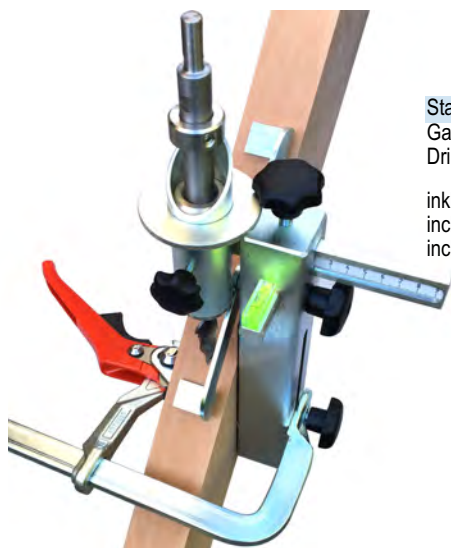

Bestellung Commande Order

Kunde, Client, Customer: _____

Kom., Commission: _____

Händler, Distributeur, Dealer: _____

www.lamifix.ch

lamifix@lamifix.ch

Tel: 0041 (0)55 225 48 48

Fax: 0041 (0)55 225 48 44



2016/17

Stufenaufdoppelung Doublage sur marche Step doubling

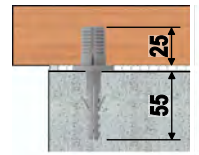
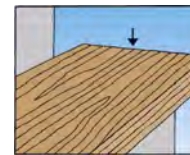
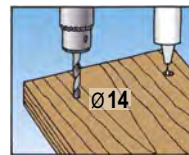
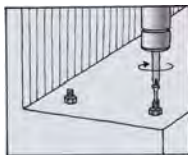
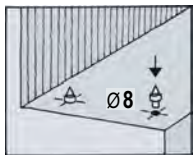

Art. / Code

| Art. / Code | | | | |
|---------------|--|----|-------|--|
| LF 1565.060.1 | Ø 8 x 55 | 50 | 75.00 | |
| LF 1565.061.1 | Markierspitze Pointe de marquage Marking-tip | 10 | 14.00 | |

Stufenabstützung und Spezialsituationen, auf Anfrage. Marche-pied et situations particulières, sur demande. Shore of steps and special situations, on request.



Bestellung Commande Order

Kunde, Client, Customer: _____

Kom., Commission: _____

Händler, Distributeur, Dealer: _____

www.lamifix.ch

lamifix@lamifix.ch

Tel: 0041 (0)55 225 48 48

Fax: 0041 (0)55 225 48 44



2016/17

Antirutschklebeband (Gummioberfläche)
Bande antidérapante (surface en gomme)
Anti - slip tape (rubber surface)



Art. / Code



Bestellung
Commande
Order

| | | | | |
|----------------------|----------------------|---|-------|--|
| LF 3925.001.1 | 1.1 x 25 mm x 18.3 m | 1 | 46.00 | |
| Schwarz, Noir, Black | | | | |

| | | | | |
|----------------------|----------------------|---|-------|--|
| LF 3925.002.1 | 0.8 x 25 mm x 18.3 m | 1 | 46.00 | |
| Schwarz, Noir, Black | | | | |

| | | | | |
|----------------------|----------------------|---|-------|--|
| LF 3925.003.1 | 1.0 x 25 mm x 18.3 m | 1 | 46.00 | |
| Transparent | | | | |

Zentrumsschraube für Spindelreppe
Vis centrale pour escalier en colimaçon
Center screw for spiral stairs



| | | | | |
|----------------------|-----|---|------|--|
| LF 3724.001.1 | M24 | 1 | 1.90 | |
|----------------------|-----|---|------|--|

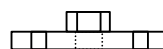

| | | | | |
|----------------------|----------------|---|-------|--|
| LF 3724.002.1 | M24 / Ø 184 mm | 1 | 65.00 | |
|----------------------|----------------|---|-------|--|

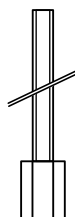

| | | | | |
|----------------------|-----------|---|-------|--|
| LF 3724.003.1 | M24 x 1 m | 1 | 49.00 | |
|----------------------|-----------|---|-------|--|

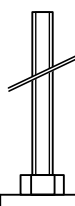

| | | | | |
|----------------------|----------------------|---|-------|--|
| LF 3724.004.1 | M24 x 1 m / Ø 184 mm | 1 | 89.00 | |
|----------------------|----------------------|---|-------|--|

Sperrholzringe auf Anfrage erhältlich.
 Anneaux en contre-plaqué disponibles sur demande.
 Plywood sleeves available on request.

Bestellung Commande Order

Kunde, Client, Customer: _____

Kom., Commission: _____

Händler, Distributeur, Dealer: _____

www.lamifix.ch

lamifix@lamifix.ch

Tel: 0041 (0)55 225 48 48

Fax: 0041 (0)55 225 48 44



2016/17



Koffer für den Treppenbau:
Für Werkstatt- und Montagearbeiten
20 Werkzeuge + 220 Sortimentsteile

Coffret de montage p. escaliers:
Pour travaux à l'atelier et au montage
20 outils et 220 éléments d'assortiment

Tool box for staircases:
For work in factory and mounting
20 tools and 220 assorted parts



Art. / Code



Bestellung
Commande
Order

LF 3401.004.5

1

1'250.00

Bestellung Commande Order

Kunde, Client, Customer: _____

Kom., Commission: _____

Händler, Distributeur, Dealer: _____

www.lamifix.ch

lamifix@lamifix.ch

Tel: 0041 (0)55 225 48 48

Fax: 0041 (0)55 225 48 44



2016/17

Handlaufstützen / Supports pour mains courantes / Supports for handrails

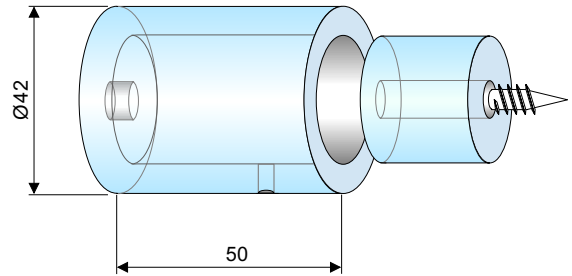

| Art. / Code | | | CHF | Bestellung Commande Order |
|---------------|---------|-----|-------|---------------------------------|
| LF 4100.004.1 | Inox A2 | 1 | 39.50 | |
| LF 4100.004.2 | | ≥10 | 37.50 | |

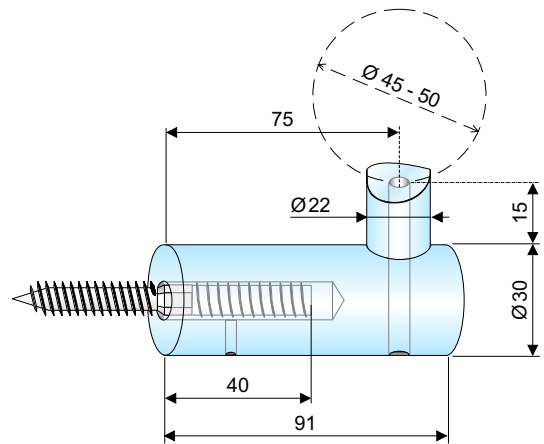

| | | | | |
|---------------|---------|-----|-------|--|
| LF 4102.005.1 | Inox A2 | 1 | 39.00 | |
| LF 4102.005.2 | | ≥10 | 37.00 | |

Befestigung an Glas / Fixation sur verre / Fastening at glass



| | | | | |
|---------------|---------|-----|-------|--|
| LF 4150.163.1 | Inox A2 | 1 | 35.00 | |
| LF 4150.163.2 | | ≥10 | 33.00 | |

Befestigung zum Einmörteln / Fixation pour mortier chimique / Fastening for cementing in bricks



| | | | | |
|---------------|---------------------|---|------|--|
| LF 1700.002.1 | Stahl, acier, steel | 1 | 3.20 | |
|---------------|---------------------|---|------|--|



Bestellung Commande Order

Kunde, Client, Customer: _____

Kom., Commission: _____

Händler, Distributeur, Dealer: _____

www.lamifix.ch

lamifix@lamifix.ch

Tel: 0041 (0)55 225 48 48

Fax: 0041 (0)55 225 48 44



2016/17

| Art. | Code | | 1 | CHF | |
|--|---|------|------|--------|--|
| | LF 35.M10x30 1035.130.1 | 25 | 3.88 | 97.00 | |
| | 1035.130.2 | 200 | 3.74 | 748.00 | |
| | LF 1435.001 1435.001.1 | 10 | | 15.50 | |
| | 1435.001.2 | ≥100 | 1.45 | | |
| | Abdeckkappe Inox-décor Capuchon, Cap | | | | |
| LF 1436. . . . Abdeckkappe, Capuchon, Cap | | | | | |
| | 1436.004.1 Buche | 1 | | 5.50 | |
| | 1436.004.2 Hêtre, Beech | ≥100 | 5.24 | | |
| | 1436.009.1 Ahorn | 1 | | 5.50 | |
| | 1436.009.2 Érable, Maple | ≥100 | 5.24 | | |
| | 1436.010.1 Eiche | 1 | | 5.50 | |
| | 1436.010.2 Chêne, Oak | ≥100 | 5.24 | | |
| | 1436.005.1 Esche | 1 | | 5.50 | |
| | 1436.005.2 Frêne, Ash | ≥100 | 5.24 | | |
| | 1436.011.1 Europ. Kirsch. | 1 | | 5.50 | |
| | 1436.011.2 Cerisier, Cherry | ≥100 | 5.24 | | |
| | 1436.013.1 Europ. Nuss. | 1 | | 5.50 | |
| | 1436.013.2 Noyer, Walnut | ≥100 | 5.24 | | |
| LF 1441. . . . Gew-Muffe, Manchon à visser, Thread sleeve | | | | | |
| | Stahl verz., acier zingué, steel galv. | | | | |
| | 1441.010.1 M10, | 25 | | 22.00 | |
| | 1441.010.2 Ø12x23 | 100 | | 86.00 | |
| | 1441.160.1 M10, | 1 | | 3.80 | |
| | 1441.160.2 Ø15x60 | ≥100 | 3.50 | | |
| LF 1442.011 1442.011.3 1 99.50 | | | | | |
| | Eindrehwerkzeug Outil à visser Screw tool → 1441.010 | | | | |
| LF 1455.010 1455.010.1 10 29.00 | | | | | |
| | 1455.010.2 | ≥100 | 2.80 | | |
| | Anschlag oben, Butée du haut, End stop top → 1571. . . . + 3805. . . . | | | | |
| LF 1456.010 1456.010.1 10 29.50 | | | | | |
| | 1456.010.2 | ≥100 | 2.78 | | |
| | Kupplung, Accouplement, Coupling → 1571. . . . | | | | |
| LF 1456. . . . Gewindestift + Kupplung verpresst | | | | | |
| Vis sans tête + Accouplement incl. pression Allen set screw + coupling incl. stamping | | | | | |
| | 1456.083.1 L = 83 | 1 | | 5.70 | |
| | 1456.083.2 | ≥100 | 5.60 | | |
| | 1456.103.1 L = 103 | 1 | | 6.30 | |
| | 1456.103.2 | ≥100 | 6.15 | | |
| LF 1458.010 1458.010.3 1 127.50 | | | | | |
| | Presswerkzeug inkl. Schlagbolzen Outil d'estampage incl. perceur | | | | |
| | Stamping tool incl. hammer bolt → 1455.010 + 1456.010 | | | | |

| Art. | Code | | CHF | |
|--|--|-----|--------|--|
| | LF 1530.006 1530.006.1 | 100 | 15.00 | |
| | 3.9 x 45 Phosphatiert, Phosphaté → Set 2 / 6 Phosphated | | | |
| LF 1541.002 1541.002.1 100 38.00 | | | | |
| | 5.5 x 32 mm Inox A2 | | | |
| | | | | |
| LF 1541.003 1541.003.1 100 39.00 | | | | |
| | 5.5 x 38 mm Inox A2 | | | |
| | | | | |
| LF 1560.003 1560.003.1 100 28.00 | | | | |
| | 6.3 x 32 mm → 1435.001 + 1436. . . . | | | |
| | | | | |
| LF 1569.010 1569.010.3 1 45.50 | | | | |
| | Stockschraubeneindreher M10 Outil pour vis à deux filetages M10 Hanger bolt driver M10 | | | |
| | | | | |
| | | | | |
| LF 1570. . . . Stockschrauben M10, Vis avec deux filetages M10, Hanger bolt M10 | | | | |
| → 3813.030 | | | | |
| | 1570.060.1 60mm | 10 | 4.30 | |
| | 1570.060.2 | 100 | 41.00 | |
| | 1570.080.1 80mm | 10 | 4.50 | |
| | 1570.080.2 | 100 | 43.00 | |
| | 1570.100.1 100mm | 10 | 5.10 | |
| | 1570.100.2 | 100 | 48.00 | |
| | 1570.120.1 120mm | 10 | 5.80 | |
| | 1570.120.2 | 100 | 55.00 | |
| | 1570.140.1 140mm | 10 | 7.50 | |
| | 1570.140.2 | 100 | 71.50 | |
| | 1570.160.1 160mm | 10 | 8.50 | |
| | 1570.160.2 | 100 | 81.00 | |
| | 1570.180.1 180mm | 10 | 10.50 | |
| | 1570.180.2 | 100 | 100.00 | |
| | 1570.200.1 200mm | 10 | 12.40 | |
| | 1570.200.2 | 100 | 118.00 | |
| LF 1571. . . . Gewindestifte + Gewindestangen, Vis sans tête + tiges filetées | | | | |
| Allen set screw + threaded rods → 1455.010 + 3806.130 | | | | |
| | 1571.003.1 | 10 | 10.00 | |
| | M10 x 35 mm | | | |
| | 1571.004.1 | 10 | 11.00 | |
| | M10 x 40 mm | | | |
| | 1571.006.1 | 10 | 15.00 | |
| | M10 x 60 mm | | | |
| | 1571.008.1 | 10 | 21.00 | |
| | M10 x 80 mm | | | |
| | 1571.097.1 | 1 | 3.85 | |
| | M10 x 1 m ± 1 cm | | | |
| | 1571.197.1 | 1 | 6.90 | |
| | M10 x 2 m ± 2 cm | | | |
| | 1571.300.1 | 1 | 15.00 | |
| | M10 x 3 m ± 3 cm | | | |

Bestellung Commande Order

Kunde, Client, Customer: _____

Kom., Commission: _____

Händler, Distributeur, Dealer: _____

www.lamifix.ch

lamifix@lamifix.ch









Tel: 0041 (0)55 225 48 48

Fax: 0041 (0)55 225 48 44



2016/17

| Art. | Code | | 1 | | |
|---|--------------------|---|------|--------|--|
|  | LF 1572.010 | 1572.010.1 | 10 | 19.00 | |
| | | 1572.010.2 | ≥100 | 1.80 | |
| | | Hutmutter M10, Inox A2 Ecrous borgnes, Cap nut | | | |
|  | LF 1620.016 | 1620.016.1 | 1 | 3.95 | |
| | | 1620.016.2 | ≥100 | 3.50 | |
| | | Ø 16 / 25 x 76 mm, Schallschutzdübel Cheville acoustique, Silencer dowel | | | |
|  | LF 1700.002 | 1700.002.1 | 1 | 3.20 | |
| | | | | | |
| | | M10, Ø 15 x 75 mm, Innengewindehülse Stahl, Douille filetage intérieur acier Steel anchor sleeve | | | |
| LF 1710. . . . Siebhülsen, Douilles de passoire, Screen tube | | | | | |
|  | | 1710.020.1 | 1 | 1.50 | |
| | | Ø 20 x 88 mm →Set 5 | ≥100 | 1.30 | |
|  | | 1710.021.1 | 1 | 1.90 | |
| | | Ø 20 x 130 mm →Set 5 XXL | ≥100 | 1.70 | |
|  | | 1710.032.1 | 1 | 3.55 | |
| | | Ø 32 x 108 mm →Set 8 | ≥100 | 3.30 | |
|  | | 1710.033.1 | 1 | 3.95 | |
| | | Ø 32 x 128 mm →Set 9 | ≥100 | 3.75 | |
|  | LF 1720.002 | 1720.002.1 | 1 | 35.50 | |
| | | | | | |
| | | Verbundmörtel Mortier chimique Injection mortar F 120 | | | |
| LF 1801. . . . Rosette, Rosace | | | | | |
|  | | 1802.016.1 | 1 | 3.95 | |
| | | Inox A2 d1 = 16, h = 7 mm →3616. . . | ≥100 | 3.75 | |
|  | | 1801.025.1 | 10 | 15.50 | |
| | | Inox-décor d1 = 25, h = 3.5 mm →3601. . . / Set: 2 - 9 | ≥100 | 1.45 | |
|  | LF 2001.250 | 2001.250.3 | 1 | 95.00 | |
| | | | | | |
| | | Bohrer mit Zentrierspitze, Mèche avec pointe de centrage, Drill with center point Ø 25 / 13 x 160 mm, HS, →2118.250 | | | |
|  | LF 2011.380 | 2011.380.3 | 1 | 93.00 | |
| | | | | | |
| | | Ø 38 / 10 x 15 mm, HW Bohrer, Mèche, Drill →1435.001 + 1436. . . | | | |
|  | LF 2033.140 | 2033.140.3 | 1 | 15.20 | |
| | | | | | |
| | | Ø 13.5 / 10 x 130 mm, HS Bohrer, Mèche, Drill →3805. . . | | | |
|  | LF 2051.003 | 2051.003.3 | 1 | 148.00 | |
| | | | | | |
| | | Stufenbohrer HS, Mèche étagée HS Stepped drill HS →Set 11, 12, 13, 31, 32 + 3805. . . | | | |

| Art. | Code | | 1 | | |
|--|--------------------|--|---|--------|--|
|  | LF 2052.003 | 2052.003.3 | 1 | 85.00 | |
| | | | | | |
| | | Staketenbohrer Ø 10mm, HS Pour barre, For bar →3905. . . | | | |
|  | LF 2055.150 | 2055.150.3 | 1 | 57.00 | |
| | | | | | |
| | | Verlängerung 135 mm Rallonge, Extension piece →2051.003 + 2052.003 | | | |
| LF 2060. . . . Bohrer, HW, Quadro, SDS-Plus Mèche, Drill | | | | | |
|  | | 2060.160.3 | 1 | 45.00 | |
| | | Ø 16 mm | | | |
| | | 2060.200.3 | 1 | 49.00 | |
| | | Ø 20 mm | | | |
| | | 2060.250.3 | 1 | 62.00 | |
| | | Ø 25 mm | | | |
| LF 2070. . . . Armierungsbohrer, Pour fer béton, Rebar cutter HW, SDS-Plus | | | | | |
|  | | 2070.200.3 | 1 | 99.00 | |
| | | Ø 20 mm | | | |
| | | 2070.250.3 | 1 | 115.00 | |
| | | Ø 25 mm →Set 7 | | | |
| | | 2070.320.3 | 1 | 125.00 | |
| | | Ø 32 mm, Für Ziegelstein, Pour briques, For bricks →Set 8 + 9 | | | |
|  | LF 2115.040 | 2115.040.3 | 2 | 59.00 | |
| | | | | | |
| | | Rosette zum Anschrauben der Bohrschablone Rosace pour visser le gabarit de perçage Screwing support for fixing drill jig | | | |
|  | LF 2116.040 | 2116.040.3 | 1 | 45.50 | |
| | | | | | |
| | | Führungshülse für Bohrbüchse Douille de guidage pour canon de perçage Guide bush for drill guide →2118. . . / 2119. . . + 2120. . . | | | |
|  | LF 2117.040 | 2117.040.3 | 1 | 32.00 | |
| | | | | | |
| | | Anschraubring Anneau à visser Screwing ring →2116.040 | | | |
|  | LF 2118.250 | 2118.250.3 | 1 | 38.50 | |
| | | | | | |
| | | Bohrbüchse für Holzbohrer, Ø 25 mm Canon de perçage pour mèche pour bois Drill guide for wood drill →2001.250 | | | |
| LF 2119. . . . Bohrbüchse für Steinbohrer Canon de perçage pour mèche pour pierre, Drill guide for rock drill | | | | | |
|  | | 2119.160.3 | 1 | 38.50 | |
| | | Ø 16 mm →2060.160 | | | |
| | | 2119.200.3 | 1 | 38.50 | |
| | | Ø 20 mm →2060.200 | | | |
| | | 2119.250.3 | 1 | 38.50 | |
| | | Ø 25 mm →2060.250 | | | |

Bestellung Commande Order

Kunde, Client, Customer: _____

Kom., Commission: _____

Händler, Distributeur, Dealer: _____

www.lamifix.ch

lamifix@lamifix.ch



Tel: 0041 (0)55 225 48 48

Fax: 0041 (0)55 225 48 44

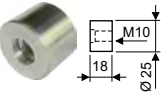
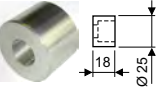
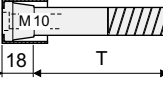
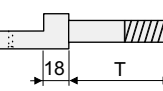
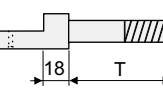
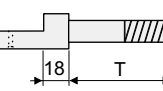

2016/17

| Art. | Code | | CHF | Sik pcs |
|---|--|----|----------|---------|
| LF 2120. . . | Bohrbüchse für Armierungsbohrer, Canon de perçage pour fer béton, Drill guide for rebar cutter | | | |
|  | 2120.200.3 Ø 20mm → 2070.200 | 1 | 38.50 | |
| | 2120.250.3 Ø 25mm → 2070.250 | 1 | 38.50 | |
| | 2120.320.3 Ø 32mm → 2070.320 | 1 | 38.50 | |
| LF 230.BIT | 2150.030.3 Bit → LF 30 + LF 35 | 1 | 37.00 | |
|  | | | | |
| LF 2150.036 | 2150.036.3 Eindreherzeug, Outil à visser Screw tool → Set 1, 2, 3624, det. A + B | 1 | 37.00 | |
|  | | | | |
| LF 2151.036 | 2151.036.3 Eindreherzeug, Outil à visser Screw tool → Set 1, 2, 3624, det. C | 1 | 37.00 | |
|  | | | | |
| LF 2198.001 | 2198.001.3 Umschaltknarre, Zubehör 5-teilig Cliquet réversible avec 5 accessoires Reversible ratchet incl. 5 attachments | 1 | 69.00 | |
|  | | | | |
| LF 2199.105 | 2199.105.3 Nutfräser 7 x 25mm Fraises à rainurer Ø 105/30mm Cutter for grooving | 1 | 329.00 | |
|  | | | | |
| LF 3401.004 | 3401.004.5 Koffer für den Treppenbau Coffret de montage pour escaliers Tool box for staircases | 1 | 1'250.00 | |
|  | | | | |
| LF 3601. . . | Abdeckhülse Inox-décor Couvercle, Cover sleeve | | | |
|  | 3601.001.1 L = 26mm → LF 3623.102 | 10 | 15.50 | |
| | 3601.002.1 L = 18mm → LF 3623.102 | 10 | 15.50 | |
| LF 3605.002 | 3605.002.1 Justierscheibe für Distanz 18 - 24 mm Rondelle de réglage pour distance Adjusting shim for distance → 3623.102 | 10 | 27.00 | |
|  | | | | |
| LF 3616. . . | Rundstab, Inox A2, Ø 16 mm Barre ronde, Round bar | | | |
|  | 3616.150.1 L = 150mm | 10 | 42.00 | |
| | 3616.180.1 L = 180mm | 10 | 47.00 | |
| | 3616.210.1 L = 210mm | 10 | 51.50 | |
| LF 3617.016 | 3617.016.1 Topf zum Einschlagen Stahl Pot pour enfoncer, Pot to hammer in → 3616. . . | 10 | 14.00 | |
|  | | | | |

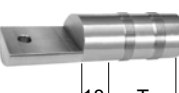
| Art. | Code | | CHF | Sik pcs |
|--|--|------|-------|---------|
| LF 3623.018 | 3623.018.1 Distanzring Inox A2 Anneau de distance, Distance ring → 1700.002 | 1 | 4.95 | |
|  | 3623.018.2 ≥100 | ≥100 | 4.50 | |
| LF 3624.018 | 3624.018.1 Distanzring Inox A2, Anneau de distance, Distance ring → Set: 21 + 22 | 1 | 4.95 | |
|  | 3624.018.2 ≥100 | ≥100 | 4.50 | |
| LF 3623.102 | 3623.102.1 T 78mm 3623.102.2 ≥100 Ø 25 / 16 mm, Anker Inox-décor Ancre, Anchor → Set: 5, 6, 7, 8, 9, det. A+B | 1 | 8.50 | |
|  | 3623.102.2 ≥100 | ≥100 | 7.90 | |
| | 3623.112.1 T 118mm Ø 25 / 16 mm, Anker Inox-décor Ancre, Anchor → Set: 5 XXL, det. A+B | 1 | 11.10 | |
|  | | | | |
| LF 3623.202 | 3623.202.1 T 78mm 3623.202.2 ≥100 Ø 25 / 16 mm, Anker, Inox A2 Ancre, Anchor → Set: 5, 6, 7, 8, 9, det. C | 1 | 11.80 | |
|  | 3623.202.2 ≥100 | ≥100 | 10.95 | |
| | 3623.112.1 T 127mm Ø 25 / 16 mm, Anker Inox A2 Ancre, Anchor → Set: 5 XXL, det. C | 1 | 14.40 | |
|  | | | | |
| LF 3623.0 . . | Bolzen zum Eindrehen, Inox A2 Boulon pour visser, Bolt to screw | | | |
|  | 3623.035.1 T 35mm | 1 | 9.95 | |
| | 3623.035.2 ≥100 | ≥100 | 9.45 | |
| | 3623.050.1 T 50mm | 1 | 10.55 | |
| | 3623.050.2 ≥100 | ≥100 | 10.00 | |
| | 3623.065.1 T 65mm | 1 | 11.65 | |
| | 3623.065.2 ≥100 | ≥100 | 11.05 | |
| | 3623.080.1 T 80mm | 1 | 12.75 | |
| | 3623.080.2 ≥100 | ≥100 | 12.10 | |
| LF 3624.0 . . | Bolzen zum Eindrehen, Inox A2 Boulon pour visser, Bolt to screw | | | |
|  | 3624.030.1 T 30mm | 1 | 9.35 | |
| | 3624.030.2 ≥100 | ≥100 | 8.88 | |
| | 3624.038.1 T 38mm | 1 | 9.40 | |
| | 3624.038.2 ≥100 | ≥100 | 8.93 | |
| LF 3623.5 . . | Bolzen zum Eindrehen, Inox A2 Boulon pour visser, Bolt to screw | | | |
|  | 3623.535.1 T 35mm | 1 | 9.95 | |
| | 3623.535.2 ≥100 | ≥100 | 9.45 | |
| | 3623.550.1 T 50mm | 1 | 10.55 | |
| | 3623.550.2 ≥100 | ≥100 | 10.00 | |
| | 3623.565.1 T 65mm | 1 | 11.65 | |
| | 3623.565.2 ≥100 | ≥100 | 11.05 | |
| | 3623.580.1 T 80mm | 1 | 12.75 | |
| | 3623.580.2 ≥100 | ≥100 | 12.10 | |

Bestellung Commande Order

Kunde, Client, Customer: _____

Kom., Commission: _____

Händler, Distributeur, Dealer: _____

www.lamifix.ch









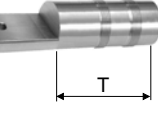

lamifix@lamifix.ch



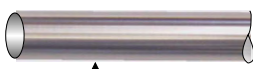





Tel: 0041 (0)55 225 48 48

Fax: 0041 (0)55 225 48 44



2016/17

| Art. | Code | | CHF | Stk/pcs |
|---|---|---|------|---------|
| LF 3624.5 .. | Bolzen zum Eindrehen, Inox A2 Boulon pour visser, Bolt to screw | | | |
|  | 3624.530.1 T 30mm | 1 | 9.35 | |
| | 3624.530.2 ≥100 | | 8.88 | |
| | 3624.538.1 T 38mm | 1 | 9.40 | |
| | 3624.538.2 ≥100 | | 8.93 | |
| LF 3625.022 | 3625.022.1 1 11.20 | | | |
| | 3625.022.2 ≥100 10.50 | | | |
|  | Auflager Ø 25mm, Inox A2 Support, IG. M10 → Set 21, 22, 50 | | | |
| LF 3625.001 | 3625.001.1 1 4.70 | | | |
|  | Waxilit, Lubrifiant, Lub → Set 1, 2 + 3624 | | | |
| LF 3802.037 | 3802.037.1 1 9.85 | | | |
| | 3802.037.2 ≥100 9.55 | | | |
|  | Tragrossette M10, Ø 37mm, Inox A2 Rosace portante centre, Support bearing → 1571... + 3805... | | | |
| LF 3803.037 | 3803.037.1 1 9.95 | | | |
| | 3803.037.2 ≥100 9.65 | | | |
|  | Endrossette M10, Ø 37mm, Inox A2 Rosace terminale, Bottom bearing → 1456... + 1571... | | | |
| LF 3805. ... | Rohr geschliffen, Tube, Inox A2 → 1455.010 + 3802.037 + 3806.130 + 3811.030 | | | |
|  | | | | |
| | 3805.097.1 1 6.65 | | | |
| | 3805.097.2 ≥100 5.95 | | | |
| | 1 m ± 1 cm | | | |
| | 3805.197.1 1 13.30 | | | |
| | 3805.197.2 ≥50 11.90 | | | |
| | 2 m ± 1 cm | | | |
| | 3805.600.1 1 39.90 | | | |
| | 3805.600.2 ≥20 35.70 | | | |
| | 6 m ± 2 cm | | | |
| LF 3805.999 | 3805.999.3 1 2.40 | | | |
|  | Zuschneiden der Rohre, Coupe de tube, Cutting of tube → 3805...  | | | |
| LF 3806.001 | 3806.001.1 100 16.00 | | | |
|  | Höhenausgleich, Élément d'ajustage, Unterlay for levelling → 3805... + 3811.030 | | | |
| LF 3806.130 | 3806.130.1 10 7.50 | | | |
| | 3806.130.2 100 72.00 | | | |
|  | Dämpfungshülse, Douille isolante, Silencer bush → 1456... + 1571... | | | |
| LF 3806.160 | 3806.160.1 100 19.00 | | | |
|  | Dämpfungsring, Rondelle isolante Silencer ring → 1455.010 + 3802.037 + 3811.030 | | | |

| Art. | Code | | CHF | Stk/pcs |
|---|--|--|-----|---------|
| LF 3806.243 | 3806.243.1 1 7.95 | | | |
|  | Schraubensicherung mittelfest, Frein filet, Threadlocker, M2 - M36 | | | |
| LF 3807.025 | 3807.025.3 1 15.00 | | | |
|  | Stirnlochschlüssel für Rosetten Clé à ergots pour rosaces Face spanner for bearings → 3802.037 + 3803.037 | | | |
| LF 3809.030 | 3809.030.1 1 3.00 | | | |
| | 3809.030.2 ≥100 2.90 | | | |
|  | Zierrossette, Inox A2, Ø 30mm Rosace décorative → 3805... | | | |
| LF 3810.030 | 3810.030.1 1 3.00 | | | |
| | 3810.030.2 ≥100 2.90 | | | |
|  | Deckenrossette Ø 30mm, Inox A2 Rosace de plafond, Ceiling rosette → 3805... | | | |
| LF 3811.030 | 3811.030.1 1 4.95 | | | |
| | 3811.030.2 ≥100 4.70 | | | |
|  | Deck-Rosette Ø 31mm, Inox A2 Rosace du haut, Ring cover top → 3805... | | | |
| LF 3813.030 | 3813.030.1 1 8.50 | | | |
| | 3813.030.2 ≥100 7.90 | | | |
|  | Rundmutter Ø 30 mm, Inox A2 Ecrou rond, Cap-nut → 1571... IG M10 Ø 6mm | | | |
| LF 3901.00. ... | Holzöhülse, Douille en bois, Wood sleeve Ø 16 / 10 x 25mm | | | |
|  | | | | |
| | 3901.001.1 Buche 10 20.00 | | | |
| | 3901.001.2 Hêtre, Beech ≥100 1.90 | | | |
| | 3901.002.1 Ahorn 10 20.00 | | | |
| | 3901.002.2 Érable, Maple ≥100 1.90 | | | |
| | 3901.003.1 Eiche 10 20.00 | | | |
| | 3901.003.2 Chêne, Oak ≥100 1.90 | | | |
| | 3901.004.1 Esche 10 20.00 | | | |
| | 3901.004.2 Frêne, Ash ≥100 1.90 | | | |
| | 3901.005.1 Europ. Nuss. 10 20.00 | | | |
| | 3901.005.2 Noyer, Walnut ≥100 1.90 | | | |
| LF 3902.020 | 3902.020.1 1 2.10 | | | |
|  | Ø 20 / 10 x 20mm Tanne, Sapin, Fir → Set 100 | | | |
| LF 3902.025 | 3902.025.1 1 2.20 | | | |
|  | Ø 25 / 16 x 20mm Tanne, Sapin, Fir → Set 101 | | | |

Bestellung Commande Order

Kunde, Client, Customer: _____

Kom., Commission: _____

Händler, Distributeur, Dealer: _____

www.lamifix.ch

lamifix@lamifix.ch

Tel: 0041 (0)55 225 48 48

Fax: 0041 (0)55 225 48 44



2016/17

| Art. | Code | | | |
|---------------------|--|-----------|----------------|--|
| LF 3905. . . | Stange geschliffen, Barre, Bar, Inox A2 →Set 31, 32, 100 + 101 | | | |
| | 3905.097.1 3905.097.2 1 m ± 1 cm | 1 ≥100 | 6.65 5.95 | |
| | 3905.197.1 3905.197.2 2 m ± 1 cm | 1 ≥50 | 13.30 11.90 | |
| | 3905.600.1 3905.600.2 6 m ± 2 cm | 1 ≥20 | 39.90 35.70 | |
| LF 3905.997 | 3805.997.3 Zuschneiden der Stangen, Coupe de barre, Cutting of bar →3905. . . | 1 | 2.40 | |
| | | | | |
| LF 3906.002 | 3906.002.3 Staketenbohrlehre Gabarit de perçage pour souspension Drill jig for hanger →3805. . . + 3905. . . | 1 | 390.00 | |
| | | | | |
| LF 3911.031 | 3911.031.1 Deck-Rosette Ø 31mm, Inox A2 Rosace du haut M10 Ring cover top →Set 31 + 32 | 1 | 7.20 | |
| | | | | |
| LF 3912.031 | 3912.031.1 Deck-Rosette Ø 31mm, Inox A2 Rosace du haut M16 Ring cover top →Set 32 | 1 | 8.50 | |
| | | | | |
| LF 3912.037 | 3912.037.1 Trag-Rosette Ø 37mm, Inox A2 Rosace portante M16 Support bearing →Set 32 | 1 | 9.95 | |
| | | | | |
| LF 3925.001 | 3925.001.1 Antirutschklebeband Bande antidérapante adhésive Anti-slip tape 1.1 x 25mm x 18.3m | 1 | 46.00 | |
| | | | | |
| LF 3925.002 | 3925.002.1 Antirutschklebeband Bande antidérapante adhésive Anti-slip tape 0.8 x 25mm x 18.3m | 1 | 46.00 | |
| | | | | |
| LF 3925.003 | 3925.003.1 Antirutschklebeband, transparent Bande antidérapante adhésive Anti-slip tape 1.0 x 25mm x 18.3m | 1 | 46.00 | |
| | | | | |

| Art. | Code | | | |
|--------------------|---|----------|----------------|--|
| LF 4100.004 | 4100.004.1 Ø 42x50mm, Inox A2 Handlaufstütze Support pour main courante Support for handrails | 1 ≥10 | 39.50 37.50 | |
| | | | | |
| LF 4102.005 | 4102.005.1 Ø 30x91mm, Inox A2 Handlaufstütze Support pour main courante Support for handrails | 1 ≥10 | 39.00 37.00 | |
| | | | | |
| LF 4200.001 | 4200.001.4 Set für Pfostenverschraubung Set pour visser le pilier Set for pile screwing | 1 | 45.00 | |
| | | | | |
| LF 4150.450 | 4150.450.1 Ø 45mm, M10 Glaspunkthalter, Inox A2 Porte-verre Glass holder | 1 | 28.00 | |
| | | | | |
| LF 4150.451 | 4150.451.3 Hakenschlüssel Clé à ergot Hook wrench | 1 | 37.00 | |
| | | | | |

Weitere Artikel

sowie Fräs- und Drehteile auf Anfrage

Autres articles

pièces tournées et de fraisage sur demande

Other articles

turned and milled parts on request

LamiFIX AG
Stampfstrasse 80
CH-8645 Jona

T: +41 (0)55 225 48 48
F: +41 (0)55 225 48 44
E: lamifix@lamifix.ch