



Tischbohrmaschine

BM-22

Art. Nr. 27022.01.000

Schnellübersicht:

- Integrierte Arbeitsleuchte
- Schnellspannbohrfutter 1-16mm
- Drehzahlverstellung mittels Keilriemen
- 5 Drehzahlen
- 1-touriger Motor
- Notausschalter
- Softhandgriffe
- Splitterschutz
- Polierter Bohrtisch mit Zentrumsbohrung
- Deckel-Endschalter



Jahre

Technische Daten:

Motorleistung	0.37 kW
Motorspannung	230 Volt
Bohrleistung in Stahl	16 mm
Bohrhub	75 mm
Bohrspindel	MK 2 / B 18
Anzahl Drehzahlen	5
Drehzahlbereich	490-2510 U / min⁻¹ (490/800/1200/1720/2510)
Tischbelastung	30 kg
T-Nutenbreite	12 mm
Gewicht	45 kg



Vermessung BM-22

Angaben in mm

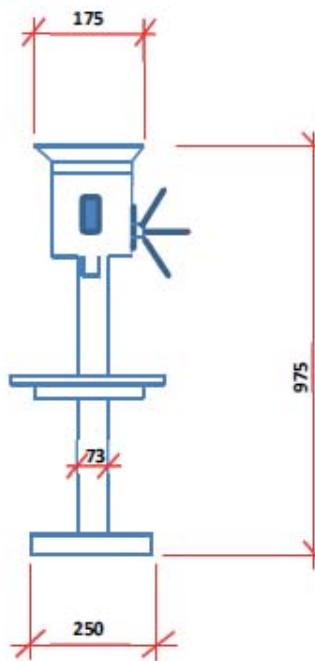
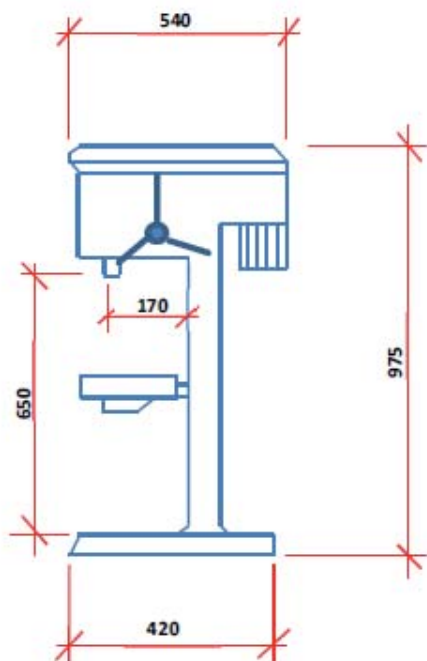



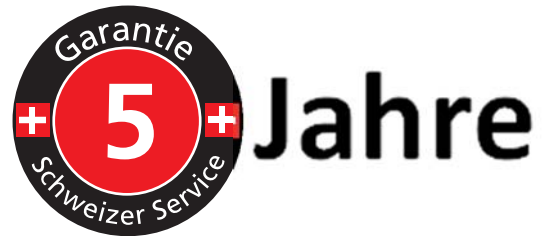

Tischabmessung: 265 x 265 x 35



Lieferumfang:

- Betriebsanleitung D / F
- Schnellspannbohrfutter 1-16mm, B 18
- Kegeldorn MK2 / B18
- Austreibdorn
- LED Arbeitsleuchte

Passendes Zubehör:

<p>Art. Nr. 27010.50.000 Maschinenschraubstock Backenbreite 80mm mit Prismenbacke</p> <p>Art. Nr. 27010.51.000 Maschinenschraubstock Backenbreite 100mm mit Prismenbacke</p>	
<p>Art. Nr. 27010.55.000 3-Weg Maschinenschraubstock Backenbreite 100mm mit Prismenbacke</p>	
<p>Art. Nr. 27030.91.000 T-Nutenschraube 12mm, M 10 komplett</p>	
<p>Art. Nr. 27010.85.000 Hochpräzisions-Schnellspannbohrfutter 3-16 mm, B 18 Backen speziell gehärtet und geschliffen für Hochpräzision</p>	

Art. Nr. 27099.00.000

Maschinenstandfuss zu Tischbohrmaschinen

Abmessungen: 550 x 350 x 850mm Gewicht 32kg



Art. Nr. 27010.98.000

Spannwerkzeugsatz 52-tlg.

T-Nutenbreite 12 mm / M10

