



## Tischbohrmaschine

### BM-20

Art. Nr. 27020.01.000



### Schnellübersicht:

- Integrierte Arbeitsleuchte
- Schnellspannbohrfutter 3-16mm
- Drehzahlverstellung mittels Keilriemen
- 5 Drehzahlen
- 1-touriger Motor
- Notausschalter
- Softhandgriffe
- Splitterschutz
- Deckel-Endschalter



# Jahre

### Technische Daten:

Motorleistung	0.37 kW
Motorspannung	230 Volt
Bohrleistung in Stahl	16 mm
Bohrhub	75 mm
Bohrspindel	MK 2
Anzahl Drehzahlen	5
Drehzahlbereich	490-2510 U / min <sup>-1</sup> (490/800/1200/1720/2510 )
Tischbelastung	30 kg
T-Nutenbreite	12 mm
Gewicht	50 kg



## Vermessung BM-20

Angaben in mm

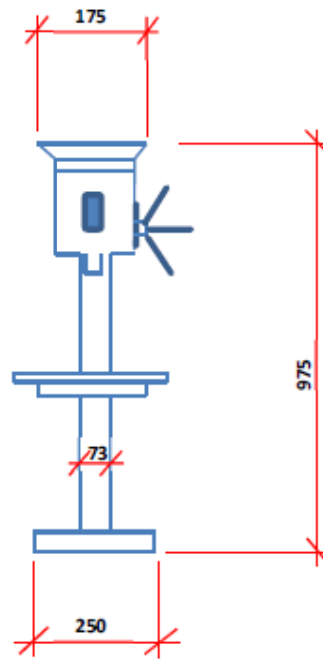
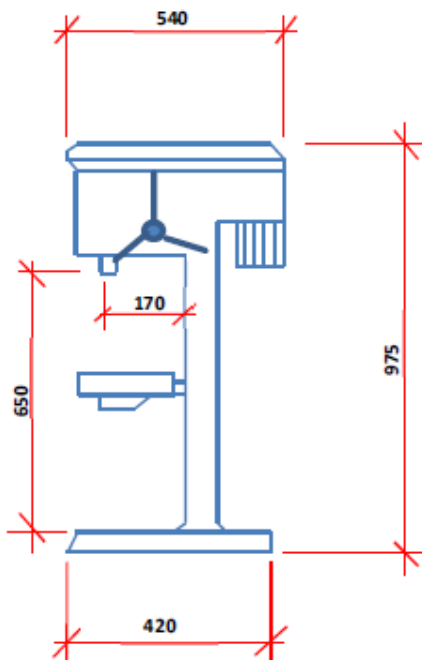



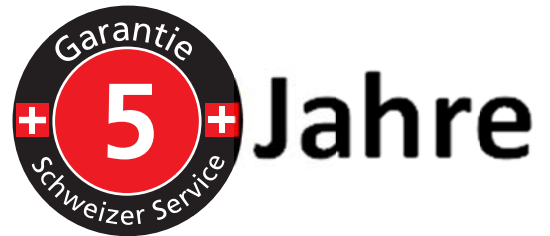

Tischabmessung: 265 x 265 x 35



### Lieferumfang:

- Betriebsanleitung D / F
- Schnellspanbohrfutter 3-16mm, B 18
- Kegeldorn MK2 / B18
- Austreibdorn

### Passendes Zubehör:

<p>Art. Nr. 27010.55.000 <b>3-Weg Maschinenschraubstock</b> Backenbreite 100mm mit Prismenbacke</p>	
<p>Art. Nr. 27030.91.000 <b>T-Nutenschraube 12mm,</b> <b>M 10 komplett</b></p>	
<p>Art. Nr. 27010.85.000 <b>Hochpräzisions-Schnellspanbohrfutter 3-16 mm, B 18</b> Backen speziell gehärtet und geschliffen für Hochpräzision</p>	
<p>Art. Nr. 27099.00.000 <b>Maschinenstandfuss zu Tischbohrmaschinen</b> Abmessungen: 550 x 350 x 850mm Gewicht 32kg</p>	
<p>Art. Nr. 27010.98.000 <b>Spannwerkzeugsatz 52-tlg.</b> T-Nutenbreite 12 mm / M10</p>	